

TravelMate 210

Service Guide

Service guide files and updates are available on the AIPG/CSD web; for more information, please refer to <http://csd.acer.com.tw>

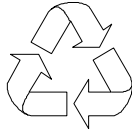

100% Recycled Paper

PART NO.: 49.40R03.001
DOC. NO.: SG362-0102A

PRINTED IN TAIWAN

Copyright

Copyright © 1999 by Acer Incorporated. All rights reserved. No part of this publication may be reproduced, transmitted, transcribed, stored in a retrieval system, or translated into any language or computer language, in any form or by any means, electronic, mechanical, magnetic, optical, chemical, manual or otherwise, without the prior written permission of Acer Incorporated.

Disclaimer

The information in this guide is subject to change without notice.

Acer Incorporated makes no representations or warranties, either expressed or implied, with respect to the contents hereof and specifically disclaims any warranties of merchantability or fitness for any particular purpose. Any Acer Incorporated software described in this manual is sold or licensed "as is". Should the programs prove defective following their purchase, the buyer (and not Acer Incorporated, its distributor, or its dealer) assumes the entire cost of all necessary servicing, repair, and any incidental or consequential damages resulting from any defect in the software.

Acer is a registered trademark of Acer Corporation.

Intel is a registered trademark of Intel Corporation.

Pentium and Pentium II/III are trademarks of Intel Corporation.

Other brand and product names are trademarks and/or registered trademarks of their respective holders.

Conventions

The following conventions are used in this manual:

Screen messages	Denotes actual messages that appear on screen.
NOTE	Gives bits and pieces of additional information related to the current topic.
WARNING	Alerts you to any damage that might result from doing or not doing specific actions.
CAUTION	Gives precautionary measures to avoid possible hardware or software problems.
IMPORTANT	Reminds you to do specific actions relevant to the accomplishment of procedures.

Preface

Before using this information and the product it supports, please read the following general information.

1. This Service Guide provides you with all technical information relating to the BASIC CONFIGURATION decided for Acer's "global" product offering. To better fit local market requirements and enhance product competitiveness, your regional office MAY have decided to extend the functionality of a machine (e.g. add-on card, modem, or extra memory capability). These LOCALIZED FEATURES will NOT be covered in this generic service guide. In such cases, please contact your regional offices or the responsible personnel/channel to provide you with further technical details.
2. Please note WHEN ORDERING FRU PARTS, that you should check the most up-to-date information available on your regional web or channel. If, for whatever reason, a part number change is made, it will not be noted in the printed Service Guide. For ACER-AUTHORIZED SERVICE PROVIDERS, your Acer office may have a DIFFERENT part number code to those given in the FRU list of this printed Service Guide. You MUST use the list provided by your regional Acer office to order FRU parts for repair and service of customer machines.

Chapter 1	System Specifications	1
	Features	1
	System Block Diagram	3
	Board Layout	4
	Top View	4
	Bottom View	5
	Panel	6
	Front Panel	6
	Left Panel	7
	Right Panel	8
	Rear Panel	8
	Bottom Panel	9
	Indicators	10
	Keyboard	11
	Special keys	11
	Hot Keys	13
	Touchpad	15
	Touchpad basics	15
	Hardware Specifications and Configurations	17
Chapter 2	System Utilities	29
	BIOS Setup Utility	29
	Navigating the BIOS Utility	29
	System Information	30
	Basic System Settings	31
	Startup Configuration	32
	Onboard Device Configuration	33
	System Security	34
	Load Default Settings	36
	BIOS Flash Utility	37
	Executing Flash Program	37
	System Utility Diskette	38
	Panel ID Utility	38
	Thermal and Fan Utility	38
	Mother Board Data Utility	38
	System Diagnostic Diskette	40
	PQA System Diagnostics	40
	Audio Resource and Speaker-Out Test	40
	USB Register and Connect/ Disconnect Test	40
	Running PQA Diagnostics Program	41
Chapter 3	Machine Disassembly and Replacement	43
	General Information	44
	Before You Begin	44
	Disassembly Procedure Flowchart	45
	Removing the Battery Pack	48
	Removing the Battery Cover	48
	Removing the CD-ROM Drive Module	49
	Disassembling the CD-ROM Drive Module	49
	Removing the Hard Disk Drive Module	51
	Disassembling the Hard Disk Drive Module	51
	Removing the Extended Memory	53
	Removing the Modem Board	54
	Disassembling the LCD	55

Table of Contents

Removing the Hinge Cap	55
Removing the Middle Cover	55
Removing the Launch Board	55
Removing the Cable Cover	56
Removing the Keyboard	56
Removing the 12.1" TFT LCD Module	57
Removing the LCD Bezel	58
Removing the Speaker	59
Removing the Inverter Board	60
Removing the LCD	60
Removing the Microphone	61
Removing the LCD Brackets	61
Removing the LCD FPC Cable	62
Disassembling the Upper Case	63
Removing the Floppy Disk Drive Module	63
Disassembling the Floppy Disk Drive Module	63
Removing the CPU Heatsink	64
Removing the RTC Battery	65
Removing the Touch Pad Cable	65
Removing the Upper Case	67
Disassembling the Lower Case	68
Removing the Charger Plate	68
Removing the Fan	68
Removing the Main Board	69
Removing the Modem Cable	70
Removing the PCMCIA Slot	71
Chapter 4 Troubleshooting	73
System Check Procedures	74
Diskette Drive Check	74
CD-ROM Drive Check	74
Keyboard or Auxiliary Input Device Check	74
Memory Check	75
Power System Check	75
Touchpad Check	76
Index of Error Message	77
Index of Symptom-to-FRU Error Message	80
Intermittent Problems	84
Undetermined Problems	85
Index of PQA Diagnostic Error Code, Message	86
Index of PQA Diagnostic Error Code, Message	87
Chapter 5 Jumper and Connector Locations	89
Top View	89
Bottom View	91
Chapter 6 FRU (Field Replaceable Unit) List	93
Appendix A Model Definition and Configuration	105
Appendix B Test Compatible Components	107
Microsoft Windows ME US/JP ACPI Environment Test	108
Appendix C Online Support Information	109
Index	111

System Specifications

Features

This computer was designed with the user in mind. Here are just a few of its many features:

Performance

- Intel® Mobile Pentium® and Celeron® CPU families 700/900 MHz processor with 128KB cache
- 64-bit memory bus
- AcerMedia bay (removable CD-ROM or DVD-ROM drive)
- Built-in floppy drive
- High-capacity, Enhanced-IDE hard disk
- NiMH main battery pack
- Power management system with ACPI (Advanced Configuration Power Interface)

Multimedia

- 16-bit high-fidelity AC'97 stereo audio with 3D sound and wavetable synthesizer
- Built-in dual speakers with microphone
- High-speed CD-ROM and DVD-ROM drive(AcerMedia Bay)
- USB video capture kit option

Connectivity

- PS/2 interface, which also can be configured as keyboard/keypad interface.
- 84/85/88 key keyboard, which is IBM PC/AT keyboard compatible.
- Universal Serial Bus Ports
- CD-ROM/DVD Swappable Module
- RJ-11 for 56Kbps fax/modem
- Upgradeable memory and hard disk
- ECP/EPP Compliant parallel port.
- RS-232 (16550 compatible) serial port

Human-centric Design and Ergonomics

- All-in-one design (CD-ROM, floppy disk drive, hard disk drive)
- Sleek, smooth and stylish design
- Full-sized keyboard
- Ergonomically centred touchpad pointing device

Expansion

- One Type III or one Type II CardBus PC card (formerly PCMCIA) slot with ZV (zoomed video) support
- Upgradeable memory and hard disk

Display

- 12.1", 13.3" or 14.1" TFT LCD displaying 32-bit true-color at 800X600 SVGA or 1024x768 XGA resolution
- 3D capabilities
- Supports other output display devices such as LCD projection panels for large audience presentations
- "Automatic LCD dim" feature that automatically decides the best settings for your display and conserves power.
- Simultaneous LCD and CRT display support
- Dual display capability

Video performance

2X AGP video graphic accelerator with 8MB shared from system memory to boost video performance.

Simultaneous display

The computer's large display and multimedia capabilities are great for giving presentations. If you prefer, you can also connect an external monitor when giving presentations. This computer has built-in AGP and VGA display system to support simultaneous LCD and CRT display. Simultaneous display allows you to control the presentation from your computer and at the same time face your audience. You can also connect other output display devices such as LCD projection panels for large-audience presentations.

Dual Display

The computer's unique graphics chip takes advantage of Windows ME's multi-display capability, allowing you to extend your desktop to an external display device, such as an external monitor projector. With this feature enabled, you can move program windows to/from the computer LCD and the external monitor.

Power management

The power management system incorporates an "automatic LCD dim" feature that automatically dims the LCD when the computer is powered by a battery pack to conserve battery power. See "Power Management" on page 26 for more information on power management features.

Opening and closing the display

To open the display, slide the display cover latch to the left and lift up the cover. Then tilt it to a comfortable viewing position. The computer employs a microswitch that turns off the display (and enters standby mode) to conserve power when you close the display cover, and turns it back on when you open the display cover.

NOTE: If an external monitor is connected, the computer turns off the display (but does not enter standby mode) when you close the display cover.

To close the display cover, fold it down gently until the display cover latch clicks into place.

WARNING: To avoid damaging the display, do not slam it when you close it. Also, do not place any object on top of the computer when the display is closed.

System Block Diagram

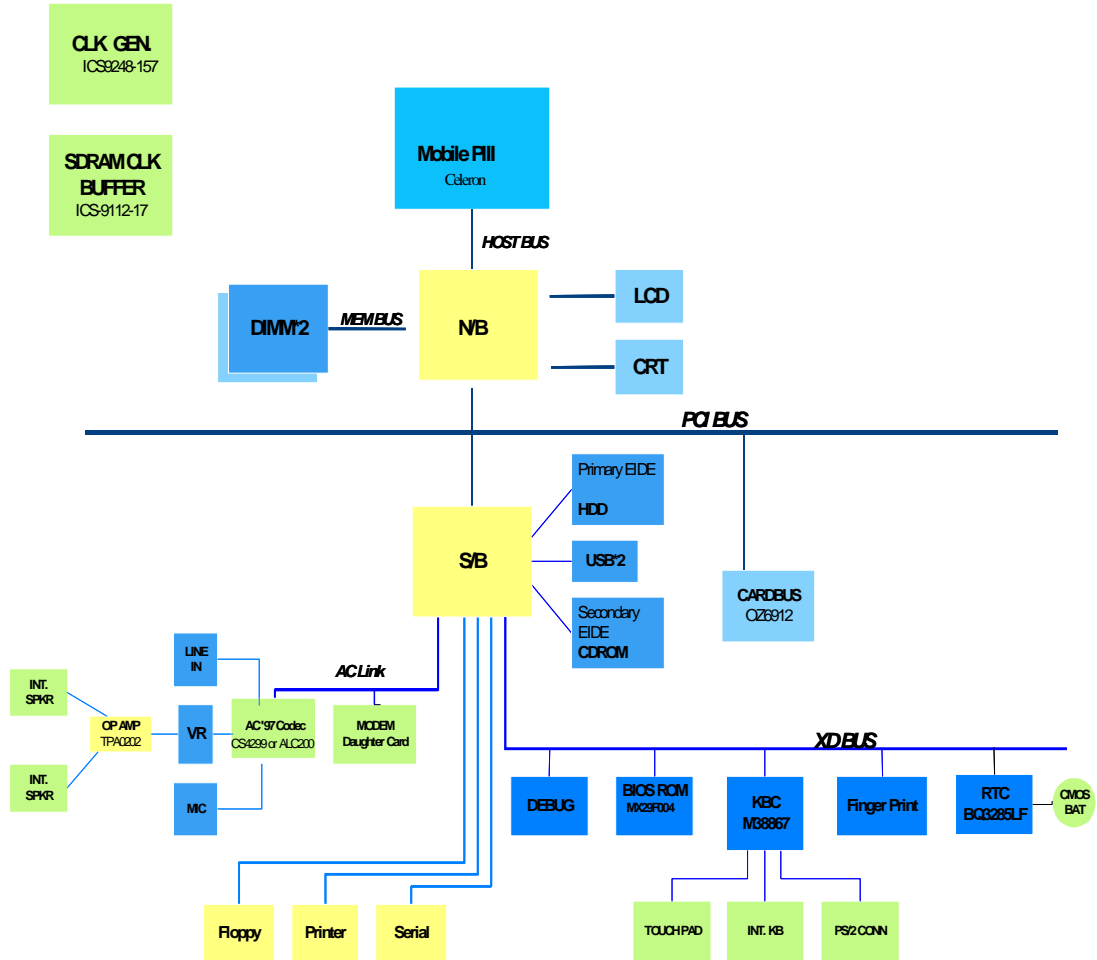

Board Layout

Top View

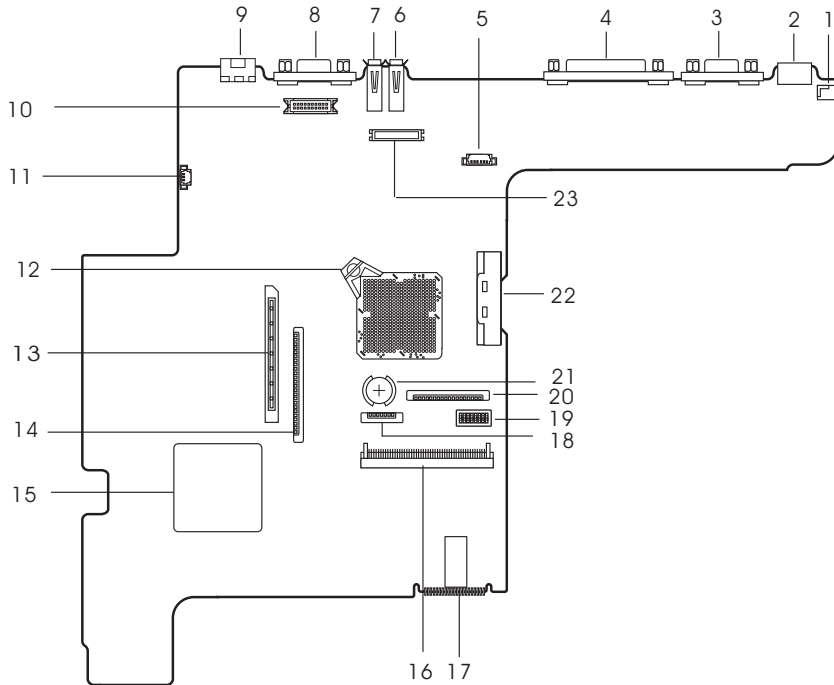

- | | |
|--------------------------------|---|
| 1 DC-in Port | 13 PCMCIA Socket Connector |
| 2 PS/2 Keyboard and Mouse Port | 14 Diskette Drive Connector |
| 3 Serial Port | 15 PCMCIA (PC card) Controller (OZ6812) |
| 4 Parallel Port | 16 HDD Connector |
| 5 Launch Key Connector | 17 BIOS ROM |
| 6 USB Port 1 | 18 Touch Pad Cable Connector |
| 7 USB Port 2 | 19 Switch |
| 8 External Display Port | 20 Keyboard Cable Connector |
| 9 Modem Port | 21 RTC battery |
| 10 LED & Inverter Connector | 22 CD-ROM Connector |
| 11 Fan Connector | 23 LCD Connector |
| 12 CPU (on board) | |

Bottom View

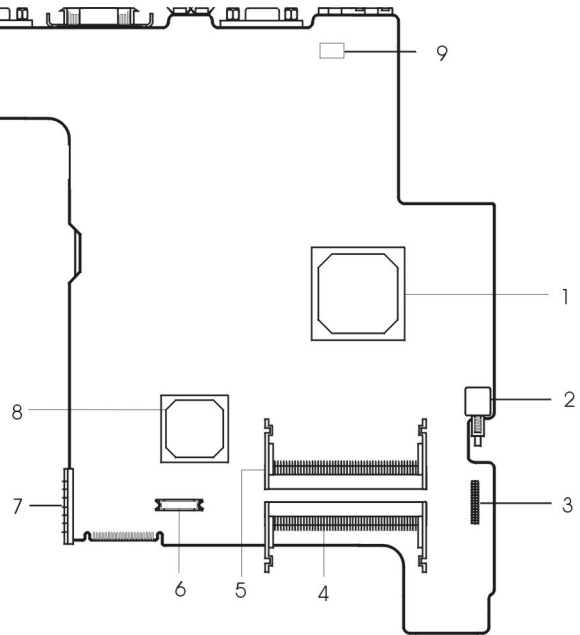

1 North Bridge (ALi M1632M)

2 Power Push Switch

3 Audio Connector

4 DIMM 2 Socket

5 DIMM 1 Socket

6 Modem Connector

7 Battery Connector

8 South Bridge (ALi M1535)

9 Modem Card Cable Connector

Panel

Ports allow you to connect peripheral devices to your computer as you would with a desktop PC.



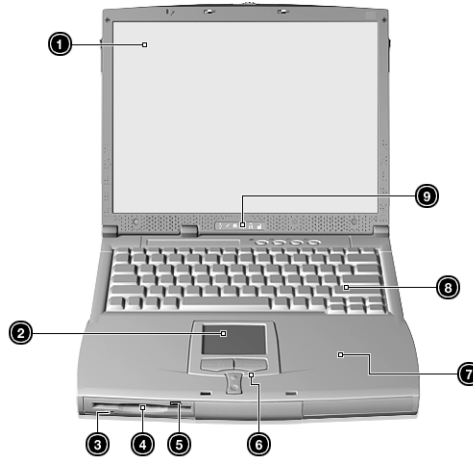

Front Panel

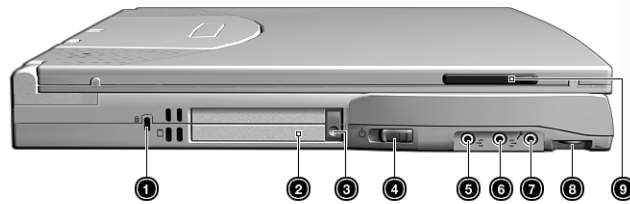

#	Item	Description
1	Display screen	Also called LCD (Liquid Crystal Display), displays computer output.
2	Touchpad	Touch-sensitive pointing device which functions like a computer mouse.
3	Floppy activity indicator	LED(light-emitting diodes) that turn on and off when the floppy is active.
4	Floppy drive	Internal diskette drive, accepts 3.5-inch floppy diskettes
5	Floppy disk eject button	Push this button to eject the floppy disk
6	Click button (left, center and right)	The left and right buttons function like the left and right mouse buttons, the center button serves as a scroll up/down button.
7	Palmrest	Comfortable support area for your hands when you use the computer.
8	Keyboard	Inputs data into your computer.
9	Status indicators	LEDs (Light Emitting Diodes) that turn on and off to show the status of the computer and its functions and components.

Left Panel



#	Icon	Item/ Port	Connects to...
1		Security keylock	Kensington-compatible key-based computer security lock.
2		PCMCIA (PC card) Port	Connects to one Type II or one Type III 16-bit PC card or 32-bit CardBus PC Card.
3		Eject button	Eject PC cards from the card slots.
4		Power switch	Turns on the computer power.
5		Speaker/ headphone-out jack	Connects to audio line-out devices (e.g., speakers, headphones)
6		Line-in jack	Accepts audio line-in devices (e.g., audio CD player, stereo walkman).
7		Microphone-in jack	Accepts a mono/stereo condenser microphone.
8		Volume control	Controls the volume of the speakers.
9		Video capture kit slot	Accepts the video capture kit option on the left side of the computer.

Right Panel

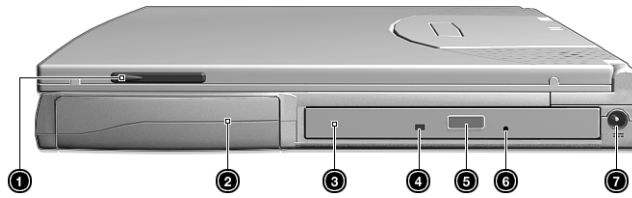



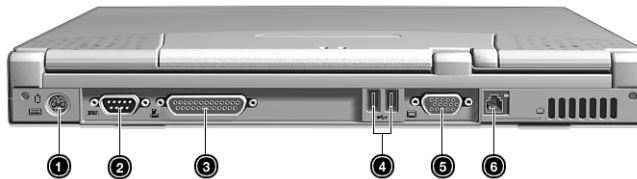

#	Icon	Item/ Port	Connects to...
1		Video capture kit slot	Accepts the video capture kit option on the right side of the computer.
2		Battery bay	Houses the computer's battery pack.
3		AcerMedia drive	Houses removable media drive modules.
4		LED indicator	Lights up when the AcerMedia drive is active.
5		Eject button	Ejects the compact disc from the drive.
6		Emergency eject slot	Ejects the compact discs when the computer is turned off.
7		Power Jack	Connects to an AC adapter

Rear Panel



#	Icon	Port	Connects to...
1		PS/2 port	Connects to any PS/2-compatible devices (e.g., PS/2 keyboard/mouse/keypad)
2		Serial port	Connects to a serial device (e.g., serial mouse)

#	Icon	Port	Connects to...
3		Parallel port	Connects to a parallel device (e.g., parallel printer)
4		USB port (two)	Connects to any Universal Serial Bus devices(e.g., USB mouse, USB camera).
5		External display port	Connects to a display device (e.g., external monitor, LCD projector) and displays up to 64K colors at 1280x1024
6		Modem jack	Connects to the phone line

Bottom Panel

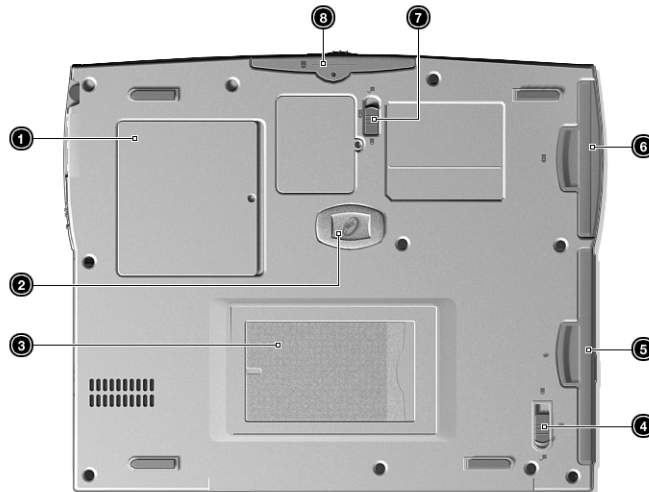







#	Item	Description
1	Memory compartment	Houses the computer's main memory.
2	Hard disk anti-shock protection	Protects your hard disk against shocks.
3	Personal identification slot	Insert a business card or similar-sized identification card to personalize your computer.
4	AcerMedia bay release latch	Unlatches the AcerMedia drive for removal or swapping.
5	AcerMedia bay	Houses an AcerMedia drive module.
6	Battery bay	Houses the computer's battery pack.
7	Battery release latch	Unlatches the battery to remove the battery pack.
8	Hard disk bay	Houses the computer's hard disk (secured by a screw).

Indicators

The computer has six easy-to-read status icons on the right of the display screen



The Power and Standby status icons are visible even when you close the display cover so you can see the status of the computer while the cover is closed.

#	Icon	Function	Description
1		Power	Lights when the computer is on.
2		Sleep	Lights when the computer enters Standby mode and blinks when it enters into or resumes from hibernation mode.
3		Media Activity	Lights when the floppy drive, hard disk or AcerMedia drive is active.
4		Battery Charge	Lights when the battery is being charged.
5		Caps Lock	Lights when Caps Lock is activated.
6		Num Lock (Fn-F11)	Lights when Numeric Lock is activated.

Keyboard

The keyboard has full-sized keys and an embedded keypad, separate cursor keys, two Windows keys and twelve function keys.

Special keys

Lock keys

The keyboard has three lock keys which you can toggle on and off.

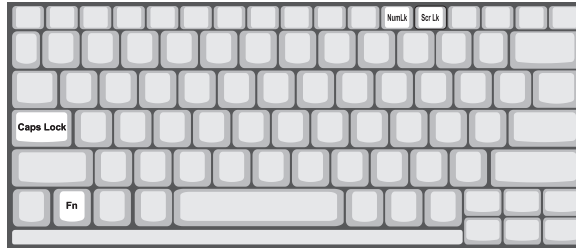

Lock key	Description
Caps Lock	When Caps Lock is on, all alphabetic characters typed are in uppercase.
Num Lock (Fn-F11)	When Num Lock is on, the embedded keypad is in numeric mode. The keys function as a calculator (complete with the arithmetic operators), -, *, and /). Use this mode when you need to do a lot of numeric data entry. A better solution would be to connect an external keypad.
Scroll Lock (Fn-F12)	When Scroll Lock is on, the screen moves one line up or down when you press the up or down arrow keys respectively. Scroll Lock does not work with some applications.

Embedded numeric keypad

The embedded numeric keypad functions like a desktop numeric keypad. It is indicated by small characters located on the upper right corner of the keycaps. To simplify the keyboard legend, cursor-control key symbols are not printed on the keys.





Desired access	Num lock on	Num lock off
Number keys on embedded keypad	Type numbers in a normal manner.	
Cursor-control keys on embedded keypad	Hold Shift while using cursor-control keys.	Hold Fn while using cursor-control keys.
Main keyboard keys	Hold Fn while typing letters on embedded keypad.	Type the letters in a normal manner.

NOTE: If an external keyboard or keypad is connected to the computer, the Num Lock feature automatically shifts from the internal keyboard to the external keyboard or keypad.

Windows keys

The keyboard has two keys that perform Windows-specific functions.



Keys	Description
Windows logo key 	Start button. Combinations with this key perform shortcut functions. Below are a few examples: ⌘ + Tab (Activates next taskbar button) ⌘ + E (Explores My Computer) ⌘ + F (Finds Document) ⌘ + M (Minimizes All) Shift + ⌘ + M (Undoes Minimize All) ⌘ + R (Displays the Run... dialog box)
Application key 	Opens a context menu (same as a right-click).

Hot Keys

The computer employs hot keys or key combinations to access most of the computer's controls like screen contrast and brightness, volume output and the BIOS Utility.

To activate hot keys, press and hold the **Fn** key before pressing the other key in the hot key combination.

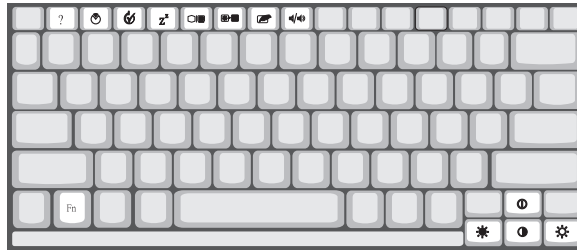

Hot Key	Icon	Function	Description
Fn-F1	?	Hotkey help	Displays a list of the hotkeys and their functions.
Fn-F2		Setup	Accesses the notebook configuration utility.
Fn-F3		Power Scheme Toggle	Switches between the power management scheme used by the computer (function available if supported by operating system).
Fn-F4	Z ²	Sleep	Puts the computer in Sleep mode.
Fn-F5		Display toggle	Switches display output between the display screen, external monitor (if connected) and both the display screen and external monitor.
Fn-F6		Screen blank	Turns the display screen backlight off to save power. Press any key to return.
Fn-F7		Touchpad Toggle	Turns the internal touchpad on and off.
Fn-F8		Speaker on/off	Turns the speakers on and off; mutes the sound.
Fn-↑		Contrast up	Increases the screen contrast (available only for models with HPA displays).
Fn-↓		Contrast down	Decreases the screen contrast (available only for models with HPA displays).
Fn-→		Brightness up	Increases the screen brightness.
Fn-←		Brightness down	Decreases the screen brightness.

Launch Keys

Located at the top of the keyboard are four buttons. These buttons are called launch keys. They are designated as key 1, key 2, key 3 and key 4. By default, key 1 is used to launch the internet browser and key 2 is used to launch the e-mail application. Keys 3 and 4 starts the Launch Manager application. All four keys can be set by the user. To set the launch keys, run the Acer Launch Manager.



Touchpad

The built-in touchpad is a PS/2-compatible pointing device that senses movement on its surface. This means that the cursor responds as you move your finger on the surface of the touchpad. The central location on the palmrest provides optimum comfort and support.

NOTE: When using an external USB or serial mouse, you can press **Fn-F7** to disable the touchpad. If you are using an external PS/2 mouse, the touchpad is automatically disabled.



Touchpad basics

The following items teach you how to use the touchpad:

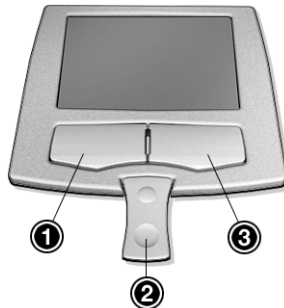

1. Move your finger across the touchpad to move the cursor.
2. Press the left (1) and right (3) buttons located on the edge of the touchpad to do selection and execution functions. These two buttons are similar to the left and right buttons on a mouse. Tapping on the touchpad produces similar results.
3. Use the center (2) buttons (top and bottom) to scroll up or down a page. This button mimics your cursor pressing on the right scroll bar of Windows applications.

Function	Left Button	Right Button	Center Button	Tap
Execute	Click twice quickly			Tap twice (at the same speed as double-clicking a mouse button)
Select	Click once			Tap once
Drag	Click and hold, then use finger to drag the cursor on the touchpad			Tap twice (at the same speed as double-clicking a mouse button) then hold finger to the touchpad on the second tap and drag the cursor
Access context menu		Click once		
Scroll			Click and hold the up/down buttons	

NOTE: Keep your fingers dry and clean when using the touchpad. Also keep the touchpad dry and clean. The touchpad is sensitive to finger movements. Hence, the lighter the touch, the better the response. Tapping harder will not increase the touchpad's responsiveness.

Hardware Specifications and Configurations

System Board Major Chips

Item	Controller
System core logic	ALI M1632M with DRAM/Cache controller
Super I/O controller	ALI M1535
Audio controller	Cirrus Logic CS4299 or Realtek ALC200 Audio Codec 97
Video controller	Trident VGA integrated by north bridge (8MB viseo RAM shared from system memory)
Hard disk drive controller	Embedded in M1535
Keyboard controller	M38867
RTC	BQ3285LF

Processor

Item	Specification
CPU type	Intel Celeron 700-900 MHz processor with 128K cache
CPU package	uBGA2
CPU core voltage	1.6V
CPU I/O voltage	1.5V

BIOS

Item	Specification
BIOS vendor	Acer BIOS
BIOS Version	V3.3
BIOS ROM type	Flash ROM
BIOS ROM size	512KB
BIOS package	32 Pin PLCC
Supported protocols	ACPI 1.0b, APM 1.2, PC Card 95, SM BIOS 2.3, EPP/IEEE 1284, ECP/IEEE 1284 1.7 & 1.9, IrDA, PCI 2.1, PnP 1.0a, PS/2 keyboard and mouse, USB, VESA VGA BIOS, DDC-2B, CD-ROM bootable, Windows keyboard Microsoft Simple Boot Flag
BIOS password control	Set by switch, see SW1 settings

Second Level Cache

Item	Specification
Cache controller	Built-in CPU
Cache size	128KB
1st level cache control	Always Enabled
2nd level cache control	Always Enabled
Cache scheme control	Fixed-in write back

System Memory

Item	Specification
Memory controller	ALI M1632
Onboard memory size	0MB
DIMM socket number	2 Sockets
Supports memory size per socket	32/64/128/256 MB
Supports maximum memory size	512 MB (256MB x 2)

System Memory

Item	Specification
Supports DIMM type	SDRAM
Supports DIMM Speed	100 MHz
Supports DIMM voltage	3.3 V
Supports DIMM package	144-pin so-DIMM
Memory module combinations	You can install memory modules in any combinations as long as they match the above specifications .

Memory Combinations

Slot 1	Slot 2	Total Memory
64MB	0MB	64 MB
0MB	64MB	64 MB
64MB	32MB	96 MB
32MB	64MB	96 MB
64MB	64MB	128 MB
0MB	128MB	128 MB
128MB	0MB	128 MB
32MB	128MB	160 MB
128MB	32MB	160 MB
64MB	128MB	192 MB
128MB	64MB	192 MB
128MB	128MB	256 MB
256MB	0MB	256MB
0MB	256MB	256MB
256MB	32MB	288MB
32MB	256MB	288MB
256MB	64MB	320MB
64MB	256MB	320MB
256MB	128MB	384MB
128MB	256MB	384MB
256MB	256MB	512MB

Above table lists some system memory configurations. You may combine DIMMs with various capacities to form other combinations.

NOTE: The shipping specification for DIMM combination is 64MB in slot 1.

Modem Interface

Item	Specification
Chipset	Ambit MDC module with Lucent modem controller
Fax modem data baud rate (bps)	14.4K
Data modem data baud rate (bps)	56K
Supports modem protocol	V.90MDC
Modem connector type	RJ11
Modem connector location	Rear side

Floppy Disk Drive Interface

Item	Specification		
Vendor & model name	MCI JU-226A252FC		
Floppy Disk Specifications			
Media recognition	2DD (720KB)	2HD (1.2 MB, 3 mode)	2HD (1.44MB)
Sectors/track	9	15	18
Tracks	80	80	80
Data transfer rate (Kbit/s)	1 MB	1.6 MB	2 MB
Rotational speed (RPM)	300	360	300
Read/write heads	2		
Encoding method	MFM		
Power Requirement			
Input Voltage (V)	+5V		

Hard Disk Drive Interface

Item	Specification	
Vendor & Model Name	IBM (DJSA-205)	IBM (DJSA-210)
Capacity (MB)	10000	5000
Bytes per sector	512	512
Logical heads	16	15
Logical sectors	63	63
Drive Format		
Logical cylinders	19485	10336
Physical read/write heads	2	1
Disks	1	1
Spindle speed (RPM)	4200RPM	4200RPM
Performance Specifications		
Buffer size	512KB	512KB
Interface	ATA-5	ATA-5
Data transfer rate (disk-buffer, Mbytes/s)	109-203	109-203
Data transfer, rate (host~buffer, Mbytes/s)	66.6 MB/Sec	
DC Power Requirements		
Voltage tolerance	5 +/- 5%	5 +/- 5%

CD-ROM Interface

Items	Specification	
Vendor & Model Name	MKE CR-177-B/D	TEAC CD-224E-B26
Performance Specification		
Transfer rate	CAV Mode: 775~1800 blocks/sec Mode 1: 1550~3600 kBytes/sec Mode 2: 1768~4106kBytes/sec	Read Sustained: 1545~3600 KB/sec Programmed I/O: 16.7 MB/sec Max. (Mode 0~4) Multi-word DMA: 16.7 MB/sec Max. (Mode 0~2) Ultra DMA: 33.3MB/sec Max.
Access time (typ.)	Random: 100 ms Full Stroke: 200 ms	Random: 115 ms Full Stroke: 250 ms
Rotation speed	5000 rpm	5136 rpm
Data Buffer Capacity	128 KB	128 KB
Interface	IDE	IDE
Applicable disc format	CD-Audio, CD-ROM (mode 1 and Mode 2), CD-ROM XA (mode 2, form 1 and form 2), CD-I (mode 2, form 1 and form 2), CD-I Ready, CD-I Bridge, Photo CD, CD-WO, Video CD, Enhanced Music CD (CD Plus), CD-RW	CD/CD-ROM(12cm,8cm), CD-R, CD-RW, CD-DA, CD-ROM(Mode 1, Mode2), CD-ROM XA (Mode 2, Form1 and Form 2), Photo CD(Singal, Multi- sессion), Enhanced CD
Loading mechanism	Drawer with soft eject and emergency eject hole	Drawer with soft eject and emergency eject hole
Power Requirement		
Input Voltage	+5V[DC]±5%	+5V[DC]±5%

DVD-ROM Interface

Item	Specification	
Vendor & model name	MKE SR-8175-BXX	
Performance Specification	With CD Diskette	With DVD Diskette
Transfer rate (KB/sec)	Average Sustained: CAV mode 775~1800 blocks/sec (10.3X to 24X) 1550~3600kBytes/sec (Mode 1) 1768~4106 kBytes/sec (Mode 2)	DVD-5: Normal Speed (1X) 11.08 Mbits/sec CAV mode 36.67~88.64 Mbits/sec DVD-9/DVD-R: Normal Speed (1X) 11.08 Mbits/sec CAV mode 36.67~88.64 Mbits/sec
Average Full Access time (typ.)	Random (*1) CAV mode 110 msec typical 150 msec average max Full Stroke (*2) CAV mode 200 msec typical 260 msec average max	DVD-5: Random (*4) 150 msec typical 200 msec average max Full Stroke (*5) 300 msec typical 400 msec average max DVD-9: Random (*7) 170 msec typical 230 msec average max Full Stroke (*8) 340 msec typical 470 msec average max
Data Buffer Capacity	512 kBytes	

DVD-ROM Interface

Item	Specification
Interface	IDE
Applicable disc format	DVD: DVD-5, DVD-9, DVD-10, DVD-R (3.95G) CD: CD-Audio, CD-ROM (mode 1 and mode 2), CD-ROM XA (mode 2, form 1 and form 2), CD-I (mode 2, form 1 and form 2), CD-I Ready, CD-I Bridge, CD-WO, CD-RW, Photo CD, Video CD, Enhanced Music CD, CD-TEXT
Loading mechanism	Soft eject (with emergency eject hole)
Power Requirement	
Input Voltage	+5V[DC]±5%

(*1) Average of Data read over the whole area from 00 min. 02 sec. 00 block to 59 min. 58 sec. 74 block more than 2000 times including latency and layered error correction time.

(*2) From 00 min. 02 sec. 00 block to 59 min. 58 sec. 74 block including latency and layered error correction time.

(*3) Disc: MNSU-005

(*4) Average of Data read over the whole area from starting data recorded area (LBA:0) to maximum data recorded area (LBA:23197F), more than 2000 times including latency and layered error correction time.

(*5) from starting data recorded area (LBA:0) to maximum data recorded area (LBA:23197F) including latency and layered error correction time.

(*6) Disk: MKE-D551.

(*7) Average of Data read over the whole area from starting data recorded area (LBA:0) to maximum data recorded area (LBA:3FA0DF), more than 2000 times including latency and layered error correction time.

(*8) from starting data recorded area (LBA:0) to maximum data recorded area (LBA:3FA0DF) including latency and layered error correction time.

(*9) Disk: ODSC-PARA

(

Audio Interface

Item	Specification
Audio Controller	Cirrus Logic Realtek ALC 200 or CS4299
Audio onboard or optional	Built-in
Mono or Stereo	Stereo
Resolution	20 bit stereo Digital to Analog converter 18 bit stereo Analog to Digital converter
Compatibility	Microsoft PC98/PC99, AC97 2.1
Mixed sound source	Line-in, CD, Video, AUX
Voice channel	8/16 bit, mono/stereo
Sampling rate	44.1 KHz
Internal microphone	Yes
Internal speaker / Quantity	Yes
Supports PnP DMA channel	DMA channel 0 DMA channel 1
Supports PnP IRQ	IRQ3, IRQ5, IRQ7, IRQ9, IRQ10, IRQ11

Video Interface

Item	Specification
Vendor & Model Name	Trident CyberBlade i1 built in M1632
Chip voltage	Core / 2.5V
Supports ZV (Zoomed Video) port	YES
Graph interface	4X AGP (Accelerated Graphic Port) Bus
Maximum resolution (LCD)	1024 x768 (24bit colors)

Video Interface

Item	Specification
Maximum resolution (CRT)	1024x768 (32 bit colors) 1280x1024 (24 bit colors) 1600x1200 (16 bit colors)

Video Memory

Item	Specification
Fixed or upgradeable	Fixed, share the system memory
Video memory size	8MB

Video Resolutions Mode

Resolution	Refresh Rate	
	CRT Only	LCD/CRT Simultaneous
640x480x256	90	60
640x480x64K	90	60
640x480x16M	90	60
800x600x256	75	60
800x600x64K	75	60
1024x768x256	60	60

Parallel Port

Item	Specification
Parallel port controller	ALI M1535
Number of parallel port	1
Location	Rear side
Connector type	25-pin D-type
Parallel port function control	Enable/Disable by BIOS Setup
Supports ECP/EPP	Yes (set by BIOS setup)
Optional ECP DMA channel (in BIOS Setup)	DMA channel 1 and 3
Optional parallel port I/O address (in BIOS Setup)	378h, 278h, 3BCh
Optional parallel port IRQ (in BIOS Setup)	IRQ7, IRQ5

Serial Port

Item	Specification
Serial port controller	ALI M1535
Number of serial port	1
Supports 16550 UART	Yes
Connector type	9-pin D-type
Location	Rear side
Serial port function control	Enable/Disable by BIOS Setup
Optional serial port (in BIOS Setup)	3F8h, 2F8h, 3E8h, 2E8h
Optional serial port IRQ (in BIOS Setup)	IRQ4, IRQ3

USB Port

Item	Specification
USB Compliancy Level	1.0
OHCI	USB 1.0
Number of USB port	2
Location	Rear side
Serial port function control	Enable/Disable by BIOS Setup

PCMCIA Port

Item	Specification
PCMCIA controller	O2-Micro Cardbus Controller OZ6812
Supports card type	Type III/II
Number of slots	One type III or one type II
Access location	Left side
Supports ZV (Zoomed Video) port	Yes
Supports 32 bit CardBus	Yes (IRQ9)

Keyboard

Item	Specification
Keyboard controller	Mitsubishi M38867
Keyboard vendor & model name	API
Total number of keypads	84-/85-/88- key
Windows 95 keys	Yes
Internal & external keyboard work simultaneously	Yes

Battery

Item	Specification
Vendor & model name	Sanyo
Battery Type	Ni-MH
Pack capacity	4000mAH
Cell voltage	1.2V
Number of battery cell	8
Package configuration	8S
Package voltage	9.6V

DC-DC/Charger Converter

Item	Specification		
Vendor & Model Name	Acer		
Input Voltage	AC Adapter or Battery: 8V - 19VDC		
DC-DC Converter Output			
Output Rating	+5V	3.3V	12V
Current (w/load, A)	0~5A	0~4A	120mA
Charger Output			
Normal charge (charge while system is not operative)	2.5A		
Background charge (charge even system is still operative)	0.8A		

DC-DC/Charger Converter

Item	Specification
Battery-low 2 level (V)	9V, typical
Battery-low 3 level (V)	8V
Protection	
Charger protection	Over Current Protection
DC/DC converter protection	OCP (Over Current Protection, A) OVP (Over Voltage Protection, V) UVP (Under Voltage Protection, V)

DC-AC LCD Inverter

Item	Specification
Vendor & model name	Ambit
Input voltage (V)	8 ~ 21V
Input current (mA)	1A (max.)
Output voltage (Vrms, no load)	1400Vrms
Output voltage frequency (kHz)	40 ~ 70KHz
Output Current/Lamp	5.5 mA ~ 6.5mA

NOTE: DC-AC inverter is used to generate very high AC voltage, then support to LCD CCFT backlight user, and is also responsible for the control of LCD brightness. Avoid touching the DC-AC inverter area while the system unit is turned on.

NOTE: There is an EEPROM in the inverter, which stores its supported LCD type and ID code. If you replace a new inverter or replace the LCD with a different brand, use Inverter ID utility to update the ID information .

LCD

Item	Specification		
Vendor & model name	12.1" Hitach TX31D35VC1CCA	13.3" ADT L133X2-3B	14.1" ADT L141X-1
Mechanical Specifications			
LCD display area (diagonal, inch)	12.1	13.3	14.1
Display technology	TFT	TFT	TFT
Resolution	SVGA (800x600)	XGA (1024x768)	XGA (1024x768)
Support colors	262K	262K	262K
Optical Specification			
Brightness control	Keyboard hotkey	Keyboard hotkey	Keyboard hotkey
Contrast control	None	None	None
Electrical Specification			
Supply voltage for LCD display (V)	3.3 (typ.)	3.3 (typ.)	3.3 (typ.)
Supply voltage for LCD backlight (Vrms)	550 (typ.)	600 (typ.)	670 (typ.)

AC Adapter

Item	Specification
Vendor & model name	Delta ADP-60DB
Input Requirements	
Maximum input current (A, @90Vac, full load)	1.5 A @ 115Vac 1.0 A @ 230Vac
Nominal frequency (Hz)	50-60
Frequency variation range (Hz)	47-63
Input voltage range (Vrms)	90-270
Inrush current	The maximum inrush current will be less than 50A and 100A when the adapter is connected to 115Vac and 230Vac respectively.
Efficiency	It should provide an efficiency of 80% minimum, when measured at maximum load under 115Vac.
Output Ratings (CV mode)	
DC output voltage	19V
Noise + Ripple	300mVp-pmax (20 MHz bandwidth)
Load	0(min) 3.16A(max)
Output Ratings (CC mode)	
DC output voltage	19V +/-1.0V for CV mode
Constant current mode	3.6 +/- 0.3A
Dynamic Output Characteristics	
Turn-on delay time	3 sec (@ 115Vac)
Hold up time	5ms (@115Vac, Full load)
Over Voltage Protection (OVP)	24V
Short circuit protection	3.9A max can be protected and output can be shorted without damage
Electrostatic discharge (ESD)	15KV (at air discharge) 8KV (at contact discharge)
Dielectric Withstand Voltage	
Primary to secondary	3000Vac
Leakage current	0.25 mA max. (@ 254Vac, 60Hz)
Regulatory Requirements	<p>Safety Requirements:</p> <ol style="list-style-type: none"> 1.The subject product rated 100-120V 60Hz must be listed under UL 1950 and certified with SCA Standard C22.2 No.950. 2.The subject product rated 200-240V 50Hz must comply with low voltage directive 73/23EEC. <p>EMI Requirements:</p> <ol style="list-style-type: none"> 1.The subject product rated 100-120V 60Hz must meet the EMI requirements of FCC part 15, Subpart B for Class B Digital Device and get FCC Certification before marketing into USA and Canada. 2.The subject product rated 200-240V 50Hz must meet the EMC Directive 89/336/EEC. 3.The subject product rated 100-120V must meet the VCCI-2 EMI requirements.

Power Management

Power Saving Mode	Phenomenon
Standby Mode Enter Standby Mode when 1. Standby/Hibernation hot-key is pressed and system is not ready to enter Hibernation mode. 2. System standby/ Hibernation timer expires and system is not ready to enter Hibernation mode.	<input type="checkbox"/> The buzzer beeps <input type="checkbox"/> The Sleep indicator lights up
Hibernation Mode Enter Hibernation Mode (suspend to HDD) when 1. Hibernation hot-key is pressed and system is ready to enter Hibernation mode 2. System Hibernation timer expires and system is ready to enter Hibernation mode.	<input type="checkbox"/> All power shuts off
Display Standby Mode Keyboard, built-in touchpad, and an external PS/2 pointing device are idle for a specified period.	<input type="checkbox"/> The display shuts off
Hard Disk Standby Mode Hard disk is idle within a specified period of time.	<input type="checkbox"/> Hard disk drive is in standby mode. (spindle turned-off)

Environmental Requirements

Item	Specification
Temperature	
Operating	+5~+35 °C
Non-operating	-20~+60 °C
Humidity	
Operating	20% to 80% RH, non-condensing
Non-operating	20% to 90% RH, non-condensing
Vibration	
Operating (unpacked)	5~25.6Hz: 0.38mm (peak to peak) 25.6~250Hz: 0.5G
Non-operating (unpacked)	5~27.1Hz: 0.6G 27.1~50Hz: 0.41mm (peak to peak) 50~500Hz: 2.0G
Non-operating (packed)	5~62.6Hz: 0.51mm (peak to peak) 62.6~500Hz: 4G

Mechanical Specification

Item	Specification
Dimensions	310(W) x 261(D) x 36.6(H)mm
Weight	6.4 lbs for 12.1" TFT model
I/O Ports	One type II or one type III PCMCIA (PC Card) port, one RJ-11 port, one DC-in port, one parallel port, one serial port, one PS/2 keyboard/mouse port, two USB port, one line-in jack, one speaker/headphone-out jack, one microphone-in jack, one external display port
Drive Bays	One
Material	Plastic
Indicators	Power-on, Standby, Battery Status, Media Access, CapsLock and NumLock
Switch	Power

Memory Address Map

Memory Address	Size	Function
00000000-0009FFFF	640 KB	Base memory
80600000-80600FFF	4 KB	Rage Mobility-M AGP
80620000-8063FFFF	128 KB	
81000000-81FFFFFF	3 MB	
000A0000-000CFFFF	192 KB	
08000000-08000FFF	4 KB	O2 Micro OZ6812 Cardbus Controller
08001000-08001FFF	4 KB	
82400000-82400FFF	4 KB	USB
82200000-82200FFF	4 KB	Audio

I/O Address Map

I/O Address	Function
000-00F	DMA controller-1
020-021	Interrupt controller-1
040-043	Timer 1
060, 064	Keyboard controller 8742 chip select
061	System speaker
066	ACPI Embedded Controller
070-073	System CMOS/RTC
080	Main board resources
081-08F	DMA Controller-1
0A0-0A1	Interrupt controller-2
0C0-0DF	DMA controller-2
0F0-0FF	Numeric data processor
170-177/376	2nd EIDE device (CD-ROM) select
1F0-1F7/3F6	1st EIDE device (hard drive) select
278-27F	Parallel port 3
2E8-2EF	Lucent Technologies Soft Modem AMR
2F8-2FF	ALi Fast Infrared Controller
378, 37F	Printer Port (LPT 1)
3B0-3BB, 3C0-3DF	Video Controller
3F0-3F5/3F7	Standard Floppy Disk Controller

I/O Address Map

I/O Address	Function
3E8-3EF	COM3
3F8-3FF	COM1 or LT Win modem (optional)
480-48F, 4D6	DMA controller-1
4D0-4D1, CF8-CFF	PCI configuration register

IRQ Assignment Map

Interrupt Channel	Function
NMI	System errors
IRQ0	System timer
IRQ1	Keyboard
IRQ2	Programmable interrupt controller
IRQ3	Reserved
IRQ4	COM1
IRQ5	Reserved
IRQ6	Floppy
IRQ7	LPT1
IRQ8	Real time clock
IRQ9	SCI
IRQ10	Audio/Modem
IRQ11	USB/VGA/Cardbus
IRQ12	PS2 pointing device
IRQ13	Numeric data processor
IRQ14	1st IDE device (hard disk)
IRQ15	2nd EIDE device (CD-ROM drive)

NOTE: IRQ settings may be changed by OS

DMA Channel Assignment

DMA Channel	Function
DRQ0	Not used
DRQ1	Not used
DRQ2	Floppy
DRQ3	Not used
DRQ4	DMA controller
DRQ5	Not used
DRQ6	Not used
DRQ7	Not used

System Utilities

BIOS Setup Utility

The BIOS Setup Utility is a hardware configuration program built into your computer's BIOS (Basic Input/Output System).

Your computer is already properly configured and optimized, and you do not need to run this utility. However, if you encounter configuration problems, you may need to run Setup. Please also refer to Chapter 4 Troubleshooting when problem arises.

To activate the BIOS Utility, press **F2** during POST (while the TravelMate logo is being displayed).

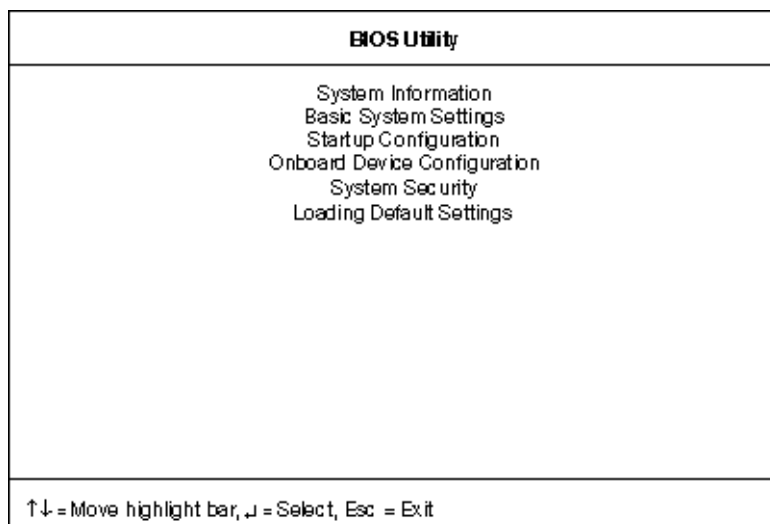

Navigating the BIOS Utility

There are six menu options: System Information, Basic System Settings, Startup Configuration, Onboard Device Configuration, System Security and Loading Default Settings.

To enter a menu, highlight the item using the **cursor up/down** keys, then press **Enter**.

Within a menu, navigate through the BIOS Utility by following these instructions:

- Press the **cursor up/down** keys to move between the parameters.
- Press the **cursor left/right** keys to change the value of a parameter.
- Press the **Esc** key while you are in any of the menu options to return to the main menu.

NOTE: You can change the value of a parameter if it is enclosed in square brackets. Navigation keys are shown at the bottom of the screen.

System Information

The System Information screen displays a summary of your computer hardware information.

System Information		Page 1/1
CPU Type & Speed -----	Celeron(TM) 650 MHz	
Floppy Disk Drive -----	1.44MB 3.5-inch	
Hard Disk Drive -----	9590 MB	
HDD Serial Number -----	41YJYNB9828	
System with -----	CD-ROM Attached	
System BIOS Version -----	V3.3 R01-A1b	
VGA BIOS Version -----	TBAV04.04	
Serial Number -----	N/A	
Asset Tag Number -----	N/A	
Product Name -----	TravelMate 210	
Manufacturer Name -----	Acer	
UUID -----	6DC6EF80CC8611D49792FD9CD030579A	
Esc = Exit		

NOTE: The screen above is a sample and may not reflect the actual data on your computer. "X" may refer to a series of numbers and/or characters.

The following table describes the information in this screen

Parameter	Description
CPU Type & Speed	Describes the type of CPU installed in the system.
Floppy Disk Drive	Shows the floppy disk drive type (1.44 MB, 3.5-inch).
Hard Disk Drive	Shows the size or capacity of the hard disk.
HDD Serial Number	Shows the serial number of the hard disk.
System with	Shows the high-capacity disc drive installed.
System BIOS Version	Shows the system BIOS version.
VGA BIOS Version	Shows the video graphics accelerator BIOS version.
Serial Number	Shows the serial number of the computer.
Asset Tag Number	Shows the asset tag number of the computer.
Product Name	Shows the official name of the product.
Manufacturer Name	Shows the manufacturer of the computer.
UUID	Shows the universally unique identifier of your computer.

The items in this screen are important and vital information about your computer. If you experience computer problems and need to contact technical support, this data helps our service personnel know more about your computer.

Basic System Settings

The Basic System Settings screen allows you to set the system date and time.

<i>Basic System Settings</i>		Page 1/1
Date	[Sat Dec 09, 2000]	
Time	[20:39:33]	
↑↓ = Move highlight bar, ←→ = Change setting, F1 = Help		

The following table describes the parameters in this screen.

Parameter	Description	Format
Date	Sets the system date.	DDD MMM DD, YYYY (day-of-the-week month day, year)
Time	Sets the system time.	HH:MM:SS (hour:minute:second)

Startup Configuration

The Startup Configuration screen contains parameter values that define how your computer behaves on system startup.

<i>Startup Configuration</i>		Page 1/1
Boot Display -----	[Both]	
Screen Expansion -----	[Enabled]	
Hotkey Beep -----	[Enabled]	
Fast Boot -----	[Enabled]	
CPU Power Management Mode-----	[Auto]	
Boot Drive Sequence:		
1st. -----	[Floppy Disk]	
2nd. -----	[CD-ROM]	
3rd. -----	[Hard Disk]	
↑↓ = Move highlight bar, ←→ = Change setting, F1 = Help		

The following table describes the parameters in this screen. Settings in **boldface** are the default and suggested parameter settings.

Parameter	Description	Options
Boot Display	Sets the display device on boot-up. When set to Auto , the computer automatically determines the display device when the computer starts up. If an external display device (e.g., monitor) is connected, it becomes the boot display; otherwise, the computer's display screen is the boot display. When set to Both , the computer outputs to both the computer display screen and an external display device if one is connected.	Both or Auto
Screen Expansion	When set to enabled, the screen will automatically adjust the display to fit the screen when the resolution is set to 640 x 480.	Enabled or Disabled
Hotkey Beep	When enabled, the computer gives off a beep when a hotkey (key combination is pressed).	Enabled or Disabled
Fast Boot	Allows you to define your system's booting process; whether to skip some POST routines or proceed with the normal booting process.	Enabled or Disabled
CPU Power Management Mode		Auto or Disabled
Boot Drive Sequence	Specifies the order in which the computer starts up from. See the section below.	1st: Floppy Disk, 2nd: CD-ROM, 3rd: Hard Disk

Setting the Boot Drive Sequence

The Boot Drive Sequence section lists boot priorities (1st, 2nd and 3rd) for bootable drives in your computer.

For example, the default value (1st:Floppy Disk, 2nd:CD-ROM and 3rd:Hard Disk) tells the computer to first search for a bootable floppy disk in the floppy drive. If it finds one present, it boots up from that floppy disk. If not, the computer continues to search for a bootable CD-ROM in the CD-ROM drive. If it cannot boot up from the CD-ROM drive, it continues by booting up from the hard disk.

To set the boot drive sequence, use the **cursor up/down keys** to select a priority level (1st, 2nd and 3rd), then use the **cursor left/right** keys to select the device for that priority level.

Onboard Device Configuration

The parameters in this screen are for advanced users only. You do not need to change the values in this screen because these values are already optimized.

The Onboard Device Configuration screen assigns resources to basic computer communication hardware.

Onboard Devices Configuration		Page 1/1
Serial Port -----	[Enabled]	
Base Address -----	[3F8h]	
IRQ -----	[4]	
Parallel Port -----	[Enabled]	
Base Address -----	[378h]	
IRQ -----	[7]	
Operation Mode -----	[Bi-directional]	
ECP DMA Channel -----	[-]	
↑↓ = Move highlight bar, ←→ = Change setting, F1 = Help		

The following table describes the parameters in this screen. Settings in **boldface** are the default and suggested parameter settings.

Parameter	Description	Options
Serial Port	Enables or disables the serial port. When enabled, you can set the base I/O address and interrupt request (IRQ) of the serial port.	Enabled or Disabled 3F8h , 2F8h, 3E8h or 2E8h 4 or 3
Parallel Port	Enables or disables the parallel port. When enabled, you can set the base I/O address, interrupt request (IRQ) and operation mode of the parallel port. If operation mode is set to ECP, the direct memory access (DMA) channel of the parallel port is set to 1.	Enabled or Disabled 378h , 278h, or 3BCh 7 or 5 Bi-directional , EPP, ECP or Standard

System Security

The System Security screen contains parameters that help safeguard and protect your computer from unauthorized use.

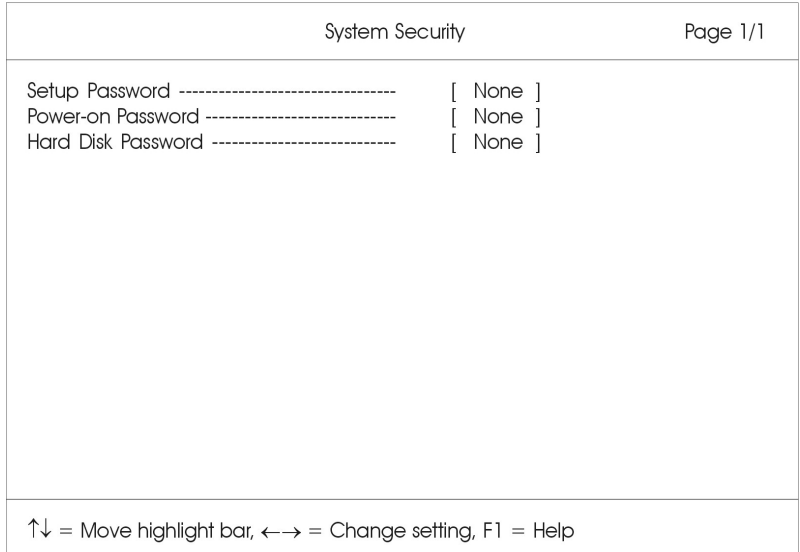

The following table describes the parameters in this screen. Settings in **boldface** are the default and suggested parameter settings.

Parameter	Description	Options
Setup Password	When set, this password protects the computer and the BIOS Utility from unauthorized entry. See the following section for instructions on how to set a password.	None or Present
Power-on Password	When set, this password protects the computer from unauthorized entry. See the following section for instructions on how to set a password.	None or Present
Hard Disk Password	When set, this password protects the hard disk from unauthorized access. See the following section for instructions on how to set a password.	None or Present

Setting a Password

Follow these steps:

1. Use the cursor up/down keys to highlight a Password parameter (Setup, Power-on or Hard Disk) and press the **cursor left/right** key. The password box appears:



2. Type a password. The password may consist of up to eight characters (A-Z, a-z, 0-9).

IMPORTANT: Be very careful when typing your password because the characters do not appear on the screen.

3. Press **Enter**. Retype the password to verify your first entry and press **Enter**.
4. After setting the password, the computer automatically sets the chosen password parameter to Present.

Three password types protect your computer from unauthorized access. Setting these passwords creates several different levels of protection for your computer and data:

- ❑ Setup Password prevents unauthorized entry to the BIOS Utility. Once set, you must key-in this password to gain access to the BIOS Utility.
- ❑ Power-On Password secures your computer against unauthorized use. Combine the use of this password with password checkpoints on boot-up and resume from hibernation for maximum security.
- ❑ Hard Disk Password protects your data by preventing unauthorized access to your hard disk. Even if the hard disk is removed from the computer and moved to another computer, it cannot be accessed without the Hard Disk Password.

When a password is set, a password prompt appears on the left-hand corner of the display screen.

1. When the Setup Password is set, the following prompt appears when you press **F2** to enter the BIOS Utility at boot-up.

Setup Password

Type the Setup Password and press **Enter** to access the BIOS Utility.

2. When the Power-on Password is set, the following prompt appears at boot-up.



Type the Power-on Password (a symbol appears for each character you type) and press **Enter** to use the computer. If you enter the password incorrectly, an **x** symbol appears. Try again and press **Enter**.

3. When the Hard Disk Password is set, the following prompt appears at boot-up.



Type the Hard Disk Password (a symbol appears for each character you type) and press **Enter** to use the computer. If you enter the password incorrectly, an **x** symbol appears. Try again and press **Enter**.

You have three chances to enter a password. If you successfully entered the password, the following symbol appears.



If you fail to enter the password correctly after three tries, the following message or symbol appears

.

Setup
Incorrect password specified. System disabled.

Power-on/Hard Disk



To change a password, follow the same steps used to set a password.

To remove a password, follow the same steps used to set a password, except type nothing in the password boxes.

Load Default Settings

If you want to restore all parameter settings to their default values, select this menu item and press **Enter**. The following dialog box displays.

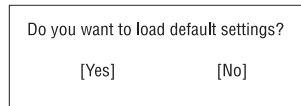

Do you want to load default settings?

[Yes] [No]

If you would like to load default settings for all parameters, use the cursor **left/right** (**→←**) keys to select **Yes**; then press **Enter**. Choose **No** if otherwise.

BIOS Flash Utility

The BIOS flash memory update is required for the following conditions:

- New versions of system programs
- New features or options

Use the AFlash utility to update the system BIOS flash ROM.

NOTE: Do not install memory-related drivers (XMS, EMS, DPMS) when you use AFlash.

NOTE: This program contains a readme.txt file. This readme.txt file will introduce on how to use AFlash utility.

Executing Flash Program

IMPORTANT: If this diskette is not bootable, do the following actions before you use it:

1. Create a bootable disk.
2. Copy all AFlash files into this bootable diskette.
3. Put the bootable disk into TravelMate 210 series module, then reboot.

IMPORTANT: Never turn off the system power while Flash BIOS is programming. This will damage your system.

4. After Flash BIOS is done, reboot the system.

NOTE: If there are any problems occurred during BIOS update, see "Index of PQA Diagnostic Error Code Message" for troubleshooting.

System Utility Diskette

This utility diskette is for the Acer TravelMate 210 notebook machine. It provides the following functions:

1. Panel ID Utility
2. Thermal & Fan Utility
3. Mother Board Data Utility

To use this diskette, first boot from this diskette, then a "Microsoft Windows ME Startup Menu" prompt you to choose the testing item. Follow the instructions on screen to proceed.

NOTE: This program contains a readme.txt file. This readme.txt file will introduce each test utility and its functions.

IMPORTANT: If this diskette is not bootable, do the following actions before you use it:

1. Do system transfers.
2. Copy the following files to A:\.
HIMEM.SYS
RAMDRIVE.SYS

Panel ID Utility

1. Read Panel ID setting

This function will display the panel ID setting of Acer TravelMate 210 series, there maybe no values in inverter if no ID is found.

2. Write Panel ID setting

This function will display a table of all panel IDs of Acer TravelMate 210 series, and ask to input the no. corresponding to the panel ID of the LCD. Then, the chosen ID will be set in EEPROM.

Thermal and Fan Utility

1. Read Thermal setting

This function will show the current thermal setting of your system and CPU which include the status, current local temp, remote temp, conversion and configuration.

2. Set Thermal setting

This function will write the default values into EEPROM.

3. Test fan

This function will test the fan.

Error message will be displayed when problem is found.

Mother Board Data Utility

1. Read Mother Board Data.

This function displays the MBD data.

2. Create MBD Header & Product & Manufacture names.

This function will create three informations and write to EEPROM automatically:

- a. Header information
- b. Product name
- c. Manufacturer name

3. Write MBD serial number

There are two sub-functions:

- a.** Create and write a new UUID - this function is used when the original UUID is lost or damaged.
 - b.** Write UUID by user keyin - this function is used when the original UUID is kept. User may use “Read Mother Board Data” function first to keep the UUID.
- 4. Write MBD serial number - this function will write MBD serial number by user keyin.**

System Diagnostic Diskette

IMPORTANT: ¹The diagnostics program here that we used is called PQA (Product Quality Assurance) and is provided by Acer Headquarters. You can utilize it as a basic diagnostic tool. To get this program, either download it from <http://csd.acer.com.tw> or find it in the TravelMate 210 service CD kit. To better fit local service requirements, your regional office MAY have other diagnostic program. Please contact your regional offices or the responsible personnel/channel to provide you with further technical details.

NOTE: This program contains a readme.txt file. This readme.txt file will introduce each test and its functions.

This diagnostic program is designed to perform the following diagnostic tools for Acer TravelMate 210 notebook machine. It provides the following functions.

1. PQA System Diagnostics
2. Audio Resource and Loopback Test
3. USB Register and Connect/ Disconnect Test

To use this diskette, first boot from this diskette, then a "Microsoft Windows ME Startup Menu" prompts you to choose the testing item. Follow the instructions on screen to proceed.

IMPORTANT: If this diskette is not bootable, do the following actions before you use it:

1. Do system transfers.
2. Copy the following files to A:\
HIMEM.SYS
RAMDRIVE.SYS
CHOICE.COM
MSCDEX.EXE

PQA System Diagnostics

NOTE: This PQA diagnostics program will test Acer TravelMate 210 notebook series' hardware peripherals.

1. When you select One Test, Test command (F2 key) will only work in the first-level menu (Item Test), if you are in sub-level menu, please press ESC to return to upper-level (Item Test) menu.
2. Use Space Bar to select/ deselect a testing item.
3. When testing is done, there will be a testing report, where you could find out whether the testing is successful or not.

Audio Resource and Speaker-Out Test

This function will test Audio Resource and Loopback of Acer TravelMate 210 notebook series. You will see "PASS" when test is successful.

You need "Loopbacker" when you choose "Loopback Test". Please put Loopbacker in Line-in, Line-out and Micro-in. You will see "PASS" when test is successful.

USB Register and Connect/ Disconnect Test

This function will test USB Register and Connect/Disconnect of TravelMate 210 notebook series.

1. Register test (USBCMD, USBINTR, FRNNUM, FLBASEADD, SOF) - test its own USB internal circuit.
2. UHCI/ OHCI test utility
 - a. Please prepare a USB device such as USB mouse, USB keyboard or USB modem, and leave the USB port disconnected. (Don't connect first)
 - b. Program will dynamically detect the incoming device for two times, please plug the USB connector in USB port first, then plug it out. (Connect one time, disconnect one time)

¹ New added description. Please pay attention to it.

-
- c. The test program will show the account of connected/ disconnected, if every steps was doing right, the screen will show "PASS", otherwise show "FAIL".

Running PQA Diagnostics Program

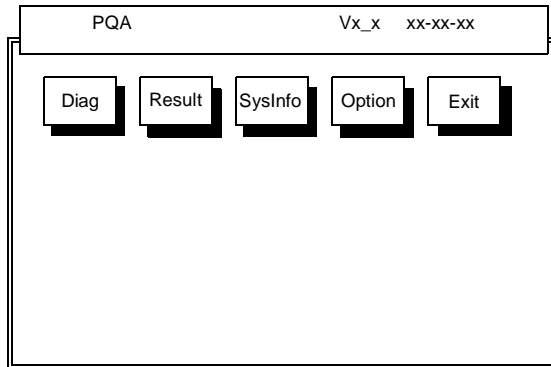

Press →← to move around the main menu. Press Enter to enable the selected option. The main options are Diag, Result, SysInfo, Option and Exit.

The Diag option lets you select testing items and times.

The following screen appears when you select Diag from the main menu.

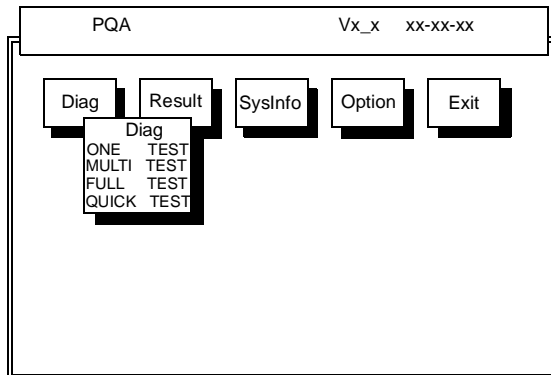

One Test performs a single test and Manual checks the selected test items in sequence.

Multi Test performs multiple tests of the selected items and check the selected test items in sequence.

Full Test performs all test items in detail for your system.

Quick Test performs all test items quickly for your system.

The screen below appears if you select Multi Test.

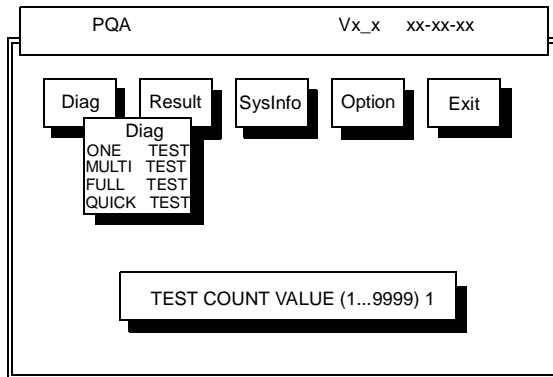

Specify the desired number of tests and press **Enter**.

After you specify the number of tests to perform, the screen shows a list of test items (see below).

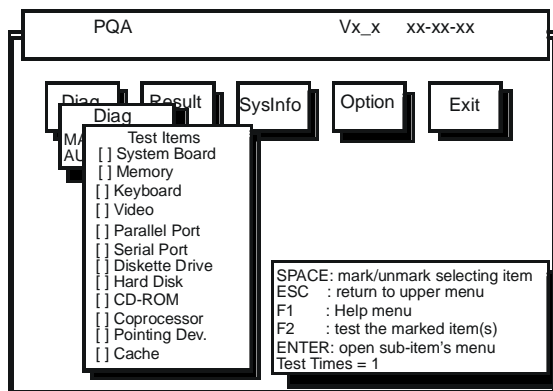

Move the highlight bar from one item to another. Press Space to enable or disable the item. Press **Enter** to view the available options of each selected item. Press **Esc** to close the submenu.

The right corner screen information gives you the available function keys and the specified test number.

- Space: Enables/disables the item
- ESC: Exits the program
- F1: Help
- F2: Tests the selected item(s)
- Enter: Opens the available options
- Test Times: Indicates the number of tests to perform.

NOTE: The F1 and F2 keys function only after you finish configuring the Test option.

NOTE: When any errors are detected by diagnostic program, refer to "Index of PQA Diagnostic Error Code" for troubleshooting.

Machine Disassembly and Replacement

This chapter contains step-by-step procedures on how to disassemble the notebook computer for maintenance and troubleshooting.

To disassemble the computer, you need the following tools:

- Wrist grounding strap and conductive mat for preventing electrostatic discharge
- Flat-bladed screw driver
- Phillips screw driver
- Tweezers
- Flat-bladed screw driver or plastic stick

NOTE: The screws for the different components vary in size. During the disassembly process, group the screws with the corresponding components to avoid mismatch when putting back the components.

General Information

Before You Begin

Before proceeding with the disassembly procedure, make sure that you do the following:

1. Turn off the power to the system and all peripherals.
2. Unplug the AC adapter and all power and signal cables from the system.

Disassembly Procedure Flowchart

The flowchart on the succeeding page gives you a graphic representation on the entire disassembly sequence and instructs you on the components that need to be removed during servicing. For example, if you want to remove the main board, you must first remove the keyboard, then disassemble the inside assembly frame in that order.

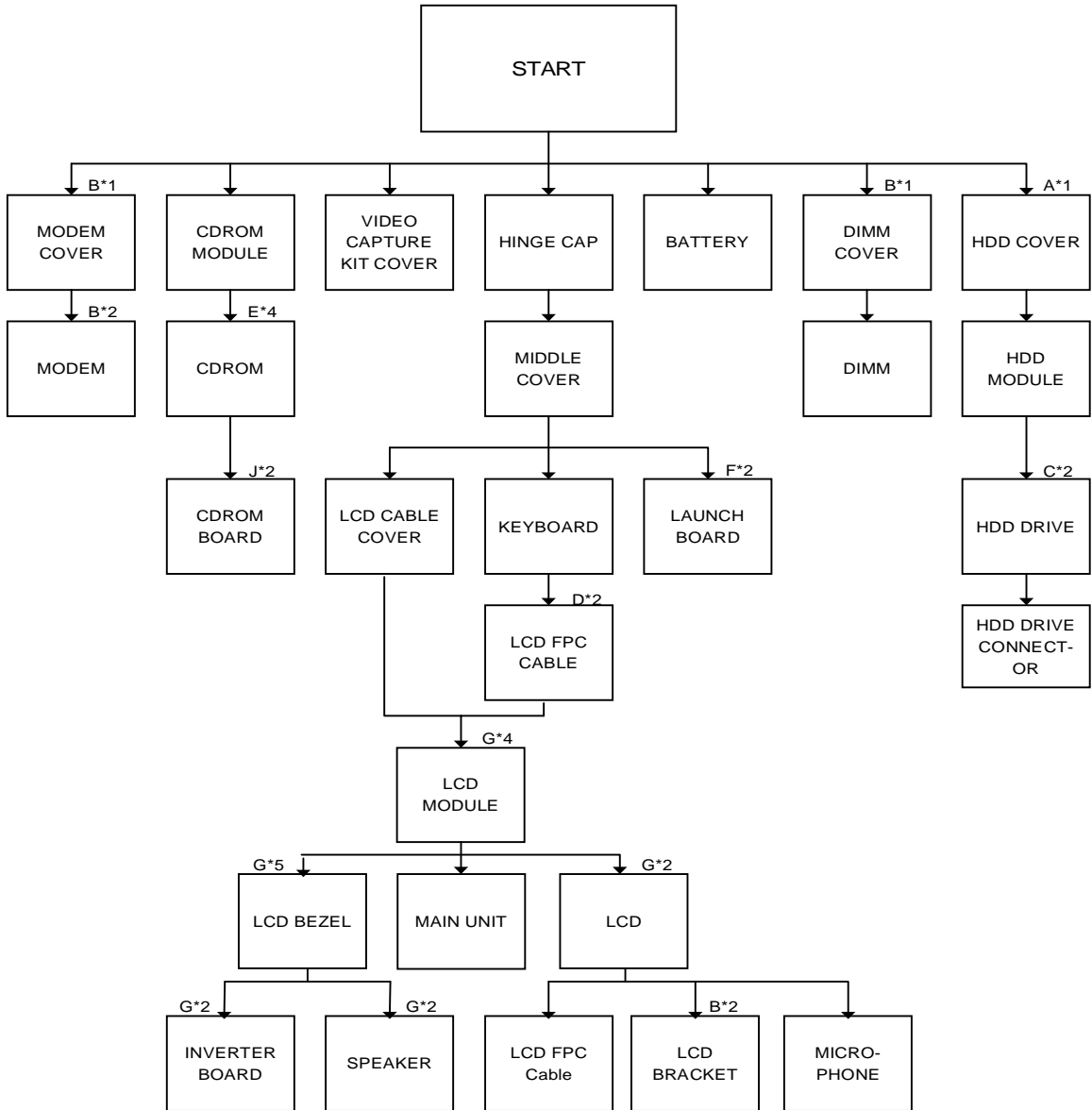

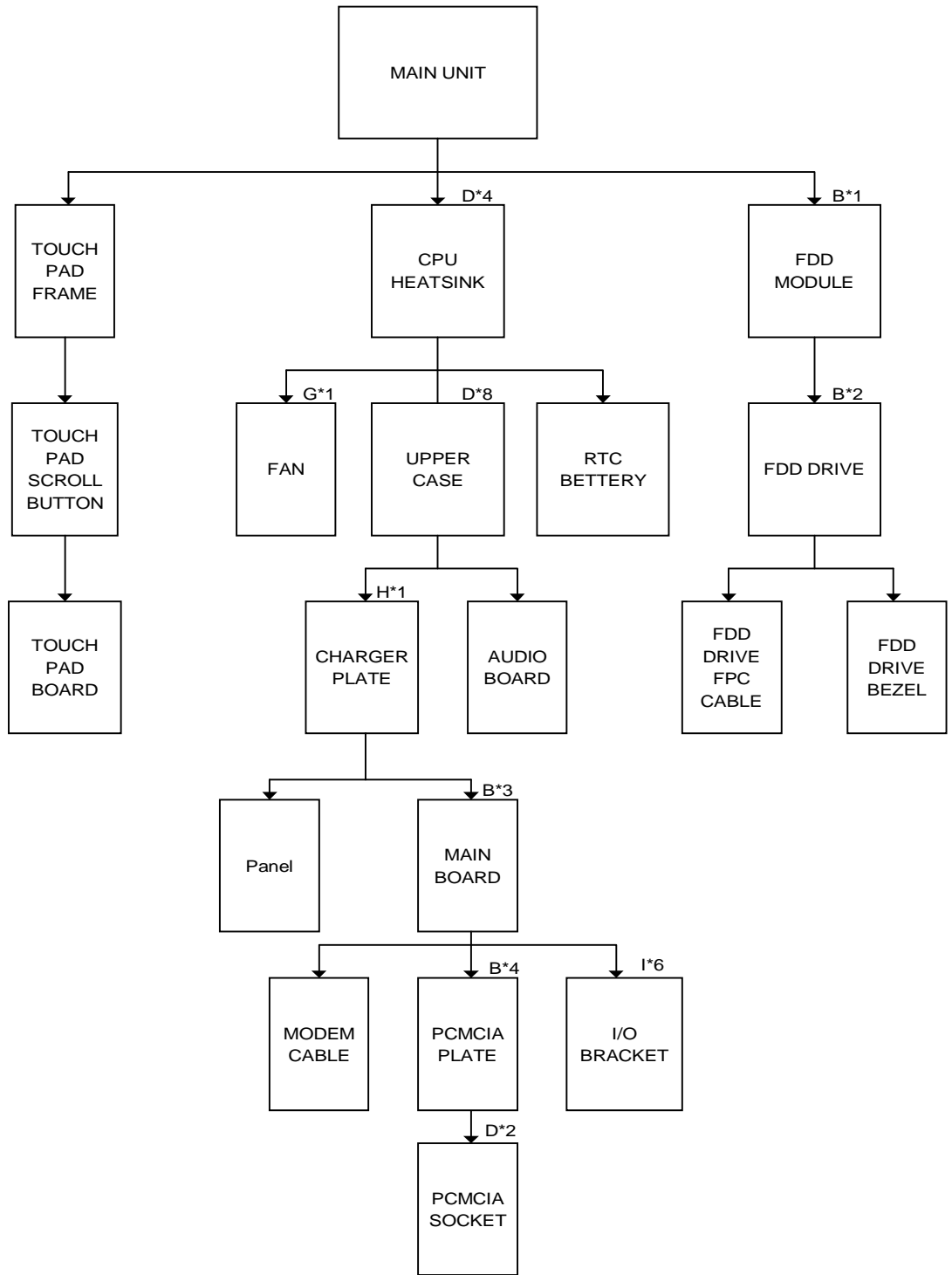

Screw List

Item	Part No.	Description
A	86.9A353.6R0	M2.5*6
B	86.4A322.4R0	M2*4L
C	86.5A524.4R0	M3*4L
D	86.1A322.120	M2.0*12
E	86.9A552.3R0	2ML3
F	86.9A322.4R0	M2.0*4
G	86.9A553.4R0	M2.5*4L
H	86.4A522.5R0	M2*5
I	34.00015.221	SCR. HEX NUT W / WASHER&NYLOK#4
J	86.00A19.120	CD-ROM SPECIAL SCREW

Removing the Battery Pack

1. To remove the battery pack, push the battery release button inward then slide the battery pack out from the machine.



Removing the Battery Cover

1. To remove the battery cover, press the cover side outward carefully then remove the cover.



Removing the CD-ROM Drive Module

1. To remove the CD-ROM drive module, push the release button outward.



2. Slide it out from the machine.



Disassembling the CD-ROM Drive Module

1. To disassemble the CD-ROM drive module, first remove four screws as shown.



2. Remove the CD-ROM drive module from the CD-ROM drive chassis.



-
3. Remove the two screws from the CD-ROM board then remove the CDROM board from the drive.



Removing the Hard Disk Drive Module

1. To remove the hard disk drive, first remove the hard disk drive cover screw, then remove the cover.

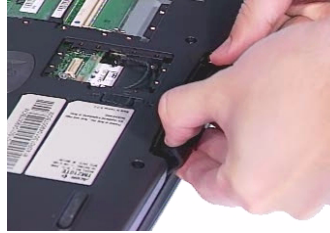

2. Remove the hard disk drive module out from the machine carefully.



Disassembling the Hard Disk Drive Module

1. To disassemble the hard disk drive module, first remove the two screws from the hard disk drive bracket.

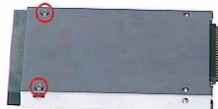

2. Remove the gasket from the hard disk drive module.



-
3. Bend both sides of the hard disk drive then remove the hard disk drive from the hard disk drive bracket.



4. Disconnect the hard disk drive connector from the hard disk drive.

Removing the Extended Memory

1. To remove the Extended memory from the machine, first remove the screw from the memory cover

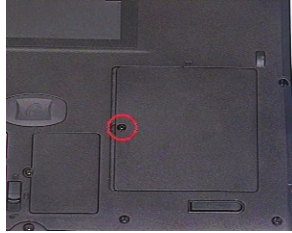

2. Push the memory cover leftward to lift the cover off, then remove the memory cover.



3. Push out the latches on both sides of the socket and pull the memory module out from the socket.



Removing the Modem Board

1. To remove the modem board, first remove the screw from the modem cover.



2. Remove the modem cover from the machine.

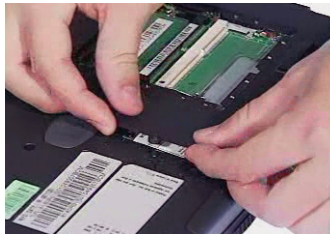

3. Remove two screws from the modem board as shown, then remove the modem board from the main unit carefully by using a plastic bladed screw driver.

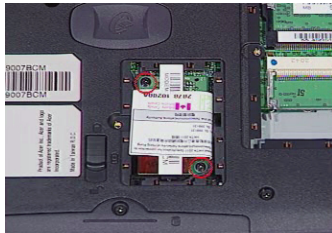

4. Disconnect the modem cable from the modem board, then remove the modem board.

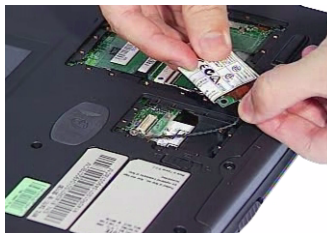

Disassembling the LCD

Removing the Hinge Cap

1. To remove the hinge caps, push the hinge caps outward then slide the hinge caps out from the main unit.

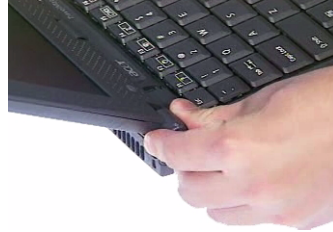

Removing the Middle Cover

1. See "Removing the Hinge Cap" on page 55
2. To remove the middle cover, push the middle cover rightward and lift the middle cover away.



Removing the Launch Board

1. See "Removing the Hinge Cap" on page 55
2. See "Removing the Middle Cover" on page 55
3. Disconnect the launch board cable from the launch board.

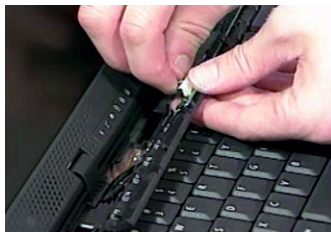

-
4. Remove the two screws from the launch board then remove the launch board from the middle cover.



Removing the Cable Cover

1. See “Removing the Hinge Cap” on page 55
2. To remove the cable cover, push the cable cover backward then pull the cover off gently.

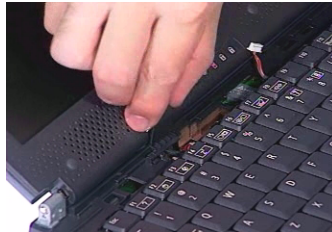

Removing the Keyboard

1. See “Removing the Hinge Cap” on page 55
2. See “Removing the Middle Cover” on page 55
3. To remove the keyboard, first pull out and upward to expose the keyboard.



-
4. Disconnect the keyboard cable from the main board carefully, then remove the keyboard from the main board.

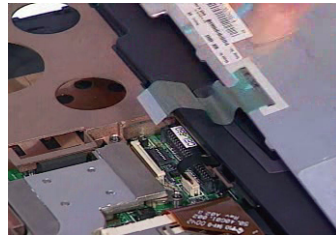
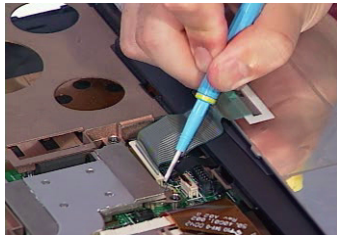

Removing the 12.1" TFT LCD Module

1. See "Removing the Hinge Cap" on page 55
2. See "Removing the Middle Cover" on page 55
3. See "Removing the Keyboard" on page 56
4. See "Removing the Cable Cover" on page 56
5. Remove the two screws from the rear of the unit and the two from the base of the unit



6. Remove the two screws from the LCD FPC cable, and then disconnect the LCD FPC cable from the main board.

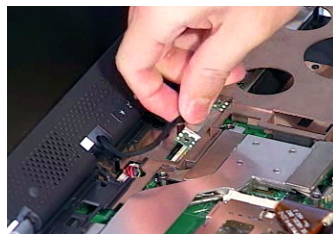
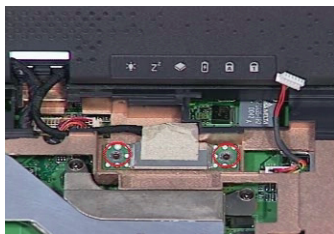

-
7. Disconnect the inverter cable from the main board and then remove the LCD module from the main unit.



8. Disconnect the the launch board cable from the main board and remove it.

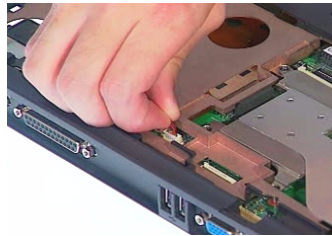

Removing the LCD Bezel

1. See "Removing the Hinge Cap" on page 55
2. See "Removing the Middle Cover" on page 55
3. See "Removing the Keyboard" on page 56
4. See "Removing the Cable Cover" on page 56
5. See "Removing the 12.1" TFT LCD Module" on page 57
6. To remove the LCD bezel, first remove the video capture kit cover from the LCD module on each side.

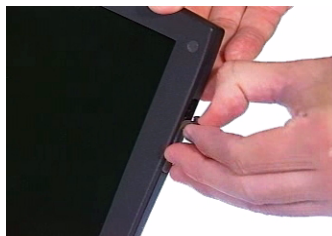

7. Remove the five LCD cushions and then remove the five screws from the LCD bezel.



-
8. Snap off the bezel carefully, and then remove the LCD bezel from the LCD module.



Removing the Speaker

1. See "Removing the Hinge Cap" on page 55
2. See "Removing the Middle Cover" on page 55
3. See "Removing the Keyboard" on page 56
4. See "Removing the Cable Cover" on page 56
5. See "Removing the 12.1" TFT LCD Module" on page 57
6. See "Removing the LCD Bezel" on page 58
7. To remove the speaker, first remove the two screws from the speaker.

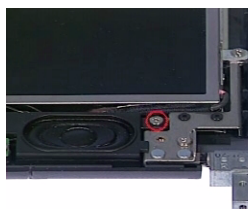

8. Detach the speaker from the LCD panel.

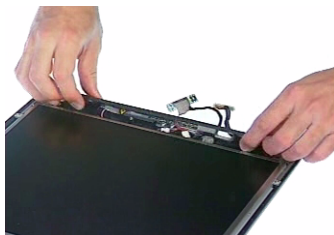

9. Disconnect the speaker cable from the speaker and then remove the speaker from the LCD module.

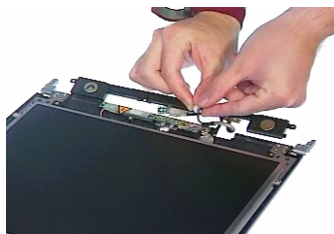

Removing the Inverter Board

1. See “Removing the Hinge Cap” on page 55
2. See “Removing the Middle Cover” on page 55
3. See “Removing the Keyboard” on page 56
4. See “Removing the Cable Cover” on page 56
5. See “Removing the 12.1” TFT LCD Module” on page 57
6. See “Removing the LCD Bezel” on page 58
7. To remove the inverter board, first remove two screws from the inverter board.

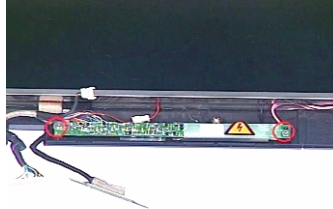

8. Disconnect the microphone cable and LCD cable from the inverter board then remove the inverter board.

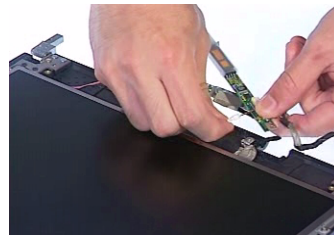
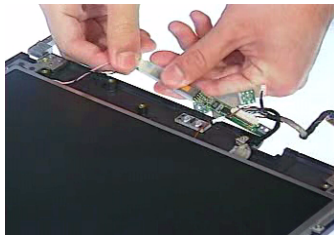

9. Disconnect the the inverter cable from the inverter board.



Removing the LCD

1. See “Removing the Hinge Cap” on page 55
2. See “Removing the Middle Cover” on page 55
3. See “Removing the Keyboard” on page 56
4. See “Removing the Cable Cover” on page 56
5. See “Removing the 12.1” TFT LCD Module” on page 57
6. See “Removing the LCD Bezel” on page 58

-
7. To remove the LCD, first remove two screws from the LCD, then remove the LCD from the LCD panel.



Removing the Microphone

1. See “Removing the Hinge Cap” on page 55
2. See “Removing the Middle Cover” on page 55
3. See “Removing the Keyboard” on page 56
4. See “Removing the Cable Cover” on page 56
5. See “Removing the 12.1” TFT LCD Module” on page 57
6. See “Removing the LCD Bezel” on page 58
7. See “Removing the LCD” on page 60
8. Remove the microphone.



Removing the LCD Brackets

1. See “Removing the Hinge Cap” on page 55
2. See “Removing the Middle Cover” on page 55
3. See “Removing the Keyboard” on page 56
4. See “Removing the Cable Cover” on page 56
5. See “Removing the 12.1” TFT LCD Module” on page 57
6. See “Removing the LCD Bezel” on page 58
7. Remove two screws on each side to remove the LCD brackets.



Removing the LCD FPC Cable

1. See “Removing the Hinge Cap” on page 55
2. See “Removing the Middle Cover” on page 55
3. See “Removing the Keyboard” on page 56
4. See “Removing the Cable Cover” on page 56
5. See “Removing the 12.1” TFT LCD Module” on page 57
6. See “Removing the LCD Bezel” on page 58
7. Remove the ESD tape then remove the LCD FPC cable from the LCD.

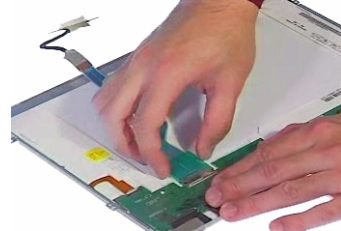
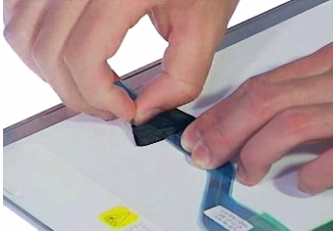

Disassembling the Upper Case

Removing the Floppy Disk Drive Module

1. See “Removing the Hinge Cap” on page 55
2. See “Removing the Middle Cover” on page 55
3. See “Removing the Keyboard” on page 56
4. See “Removing the Cable Cover” on page 56
5. See “Removing the 12.1” TFT LCD Module” on page 57
6. To remove the floppy disk drive module, first remove the screw from the upper case.

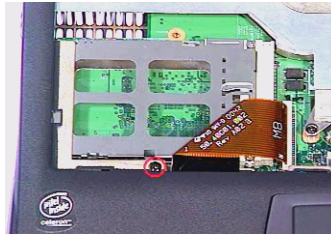

7. Disconnect the floppy disk drive cable from the main unit, then pull the floppy disk drive module out from the main unit carefully.

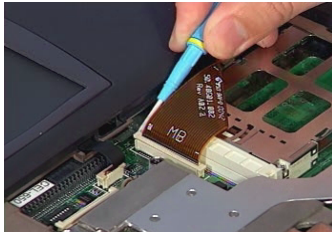

Disassembling the Floppy Disk Drive Module

1. See “Removing the Hinge Cap” on page 55
2. See “Removing the Middle Cover” on page 55
3. See “Removing the Keyboard” on page 56
4. See “Removing the Cable Cover” on page 56
5. See “Removing the 12.1” TFT LCD Module” on page 57
6. See “Removing the Floppy Disk Drive Module” on page 63

-
7. To disassemble the floppy disk drive module, first disconnect the floppy disk drive FPC cable from the drive.



8. Detach the bezel from the drive carefully.



9. Remove the two screws from the floppy disk drive bracket and remove the bracket from the drive.



Removing the CPU Heatsink

1. See “Removing the Hinge Cap” on page 55
2. See “Removing the Middle Cover” on page 55
3. See “Removing the Keyboard” on page 56
4. See “Removing the Cable Cover” on page 56
5. See “Removing the 12.1” TFT LCD Module” on page 57
6. Remove four screws from the CPU heatsink.

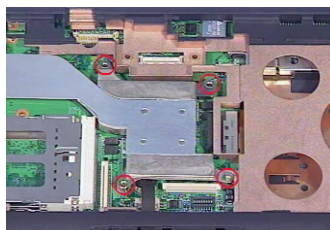

-
7. Pull the CPU heatsink backward then rightward from the main unit.



Removing the RTC Battery

1. See “Removing the Hinge Cap” on page 55
2. See “Removing the Middle Cover” on page 55
3. See “Removing the Keyboard” on page 56
4. See “Removing the Cable Cover” on page 56
5. See “Removing the 12.1” TFT LCD Module” on page 57
6. See “Removing the CPU Heatsink” on page 64
7. Use flat-bladed screwdriver to remove the RTC battery gently.

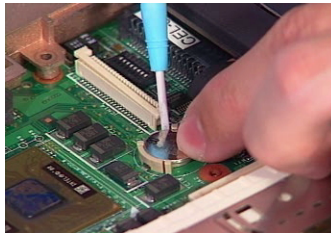

Removing the Touch Pad Cable

1. See “Removing the Hinge Cap” on page 55
2. See “Removing the Middle Cover” on page 55
3. See “Removing the Keyboard” on page 56
4. See “Removing the Cable Cover” on page 56
5. To remove the touch pad cable, first disconnect the touch pad cable from the main board.

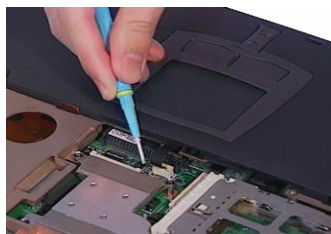

-
6. Remove the touch pad frame from the upper case carefully.



7. Remove the touchpad scroll from the upper case.

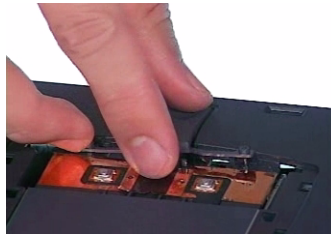

8. Remove the touch pad board then disconnect the touch pad cable from the touch pad board.

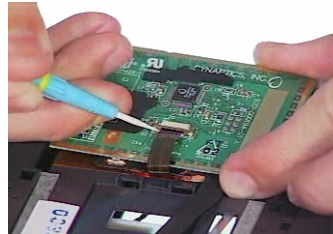
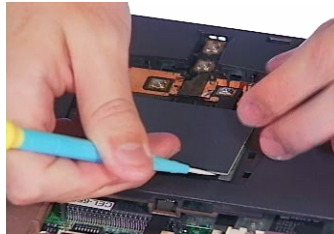

9. Remove the touch pad cable form the upper case carefully.



Removing the Upper Case

1. See “Removing the Hinge Cap” on page 55
2. See “Removing the Middle Cover” on page 55
3. See “Removing the Keyboard” on page 56
4. See “Removing the Cable Cover” on page 56
5. See “Removing the 12.1” TFT LCD Module” on page 57
6. See “Removing the CPU Heatsink” on page 64
7. To remove the upper case, first remove eight screws from the base of the unit as shown.

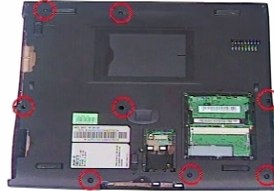

8. Pull the upper case from the unit gently.



Disassembling the Lower Case

Removing the Charger Plate

1. See “Removing the Hinge Cap” on page 55
2. See “Removing the Middle Cover” on page 55
3. See “Removing the Keyboard” on page 56
4. See “Removing the Cable Cover” on page 56
5. See “Removing the 12.1” TFT LCD Module” on page 57
6. See “Removing the CPU Heatsink” on page 64
7. See “Removing the Upper Case” on page 67
8. To remove the charger plate, first remove the screw from the charger plate then remove the charger plate from the main board.

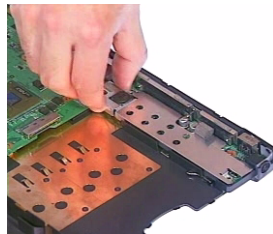
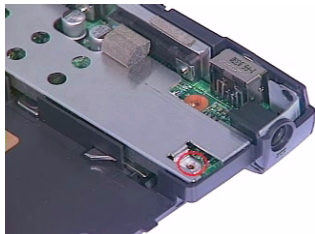

Removing the Fan

1. See “Removing the Hinge Cap” on page 55
2. See “Removing the Middle Cover” on page 55
3. See “Removing the Keyboard” on page 56
4. See “Removing the Cable Cover” on page 56
5. See “Removing the 12.1” TFT LCD Module” on page 57
6. See “Removing the CPU Heatsink” on page 64
7. See “Removing the Upper Case” on page 67
8. To remove the Fan, first disconnect the fan cable from the main board.

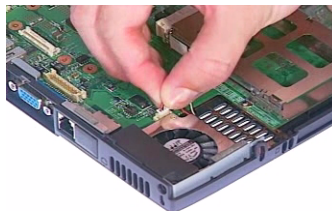

-
9. Remove the screw from the Fan, then remove the fan from the panel.

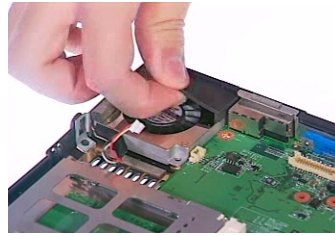
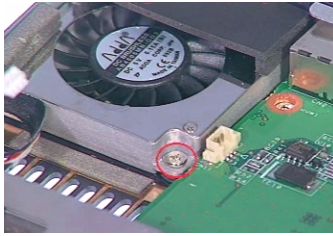

Removing the Main Board

1. See "Removing the Hinge Cap" on page 55
2. See "Removing the Middle Cover" on page 55
3. See "Removing the Keyboard" on page 56
4. See "Removing the Cable Cover" on page 56
5. See "Removing the 12.1" TFT LCD Module" on page 57
6. See "Removing the CPU Heatsink" on page 64
7. See "Removing the Upper Case" on page 67
8. See "Removing the Charger Plate" on page 68
9. See "Removing the Fan" on page 68
10. Remove three screws from the main board as shown.

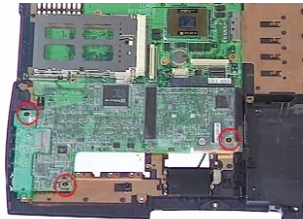

11. Pull the audio jack connector and battery connector out to remove the main board from the panel carefully.

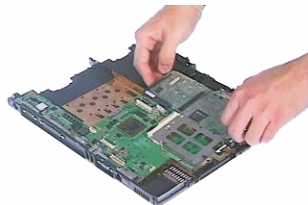

-
12. Detach the audio board from the main board.

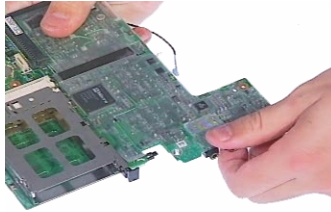

Removing the Modem Cable

1. See “Removing the Hinge Cap” on page 55
2. See “Removing the Middle Cover” on page 55
3. See “Removing the Keyboard” on page 56
4. See “Removing the Cable Cover” on page 56
5. See “Removing the 12.1” TFT LCD Module” on page 57
6. See “Removing the CPU Heatsink” on page 64
7. See “Removing the Upper Case” on page 67
8. See “Removing the Charger Plate” on page 68
9. See “Removing the Fan” on page 68
10. See “Removing the Main Board” on page 69
11. To remove the modem cable, first disconnect the modem cable from the main board.

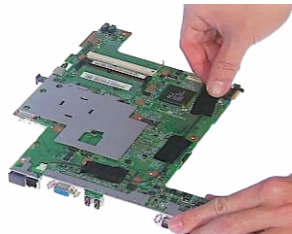

12. Remove the modem cable from the main board.

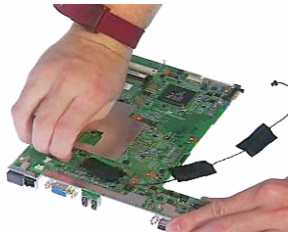

Removing the PCMCIA Slot

1. See “Removing the Hinge Cap” on page 55
2. See “Removing the Middle Cover” on page 55
3. See “Removing the Keyboard” on page 56
4. See “Removing the Cable Cover” on page 56
5. See “Removing the 12.1” TFT LCD Module” on page 57
6. See “Removing the CPU Heatsink” on page 64
7. See “Removing the Upper Case” on page 67
8. See “Removing the Charger Plate” on page 68
9. See “Removing the Fan” on page 68
10. See “Removing the Main Board” on page 69
11. Remove four screws from the PCMCIA plate to remove the plate.

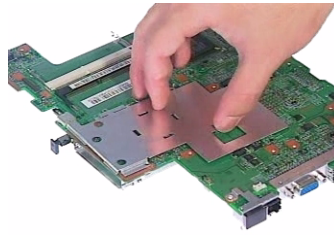
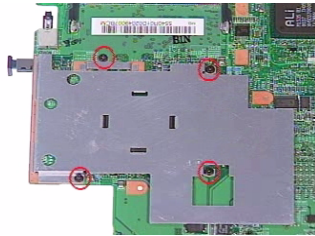

12. Remove two screws from the PCMCIA slot to detach it from the main board.

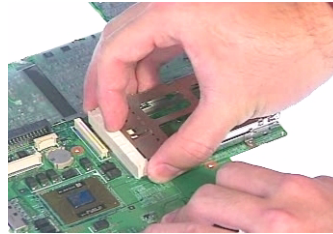
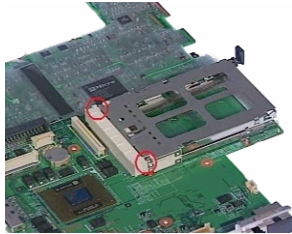

Troubleshooting

Use the following procedure as a guide for computer problems.

NOTE: The diagnostic tests are intended to test only Acer products. Non-Acer products, prototype cards, or modified options can give false errors and invalid system responses.

1. Obtain the failing symptoms in as much detail as possible.
2. Verify the symptoms by attempting to re-create the failure by running the diagnostic test or by repeating the same operation.
3. Use the following table with the verified symptom to determine which page to go to.

Symptoms (Verified)	Go To
Power failure. (The power indicator does not go on or stay on.)	Power System check
POST does not complete. No beep or error codes are indicated.	Symptom-to-FRU Index Undetermined Problems
POST detects an error and displayed messages on screen.	Error Messages List
The diagnostic test detected an error and displayed a FRU code.	Running PQA Diagnostic Program
Other symptoms (i.e. LCD display problems or others).	Error Symptom-to-FRU Index
Symptoms cannot be re-created (intermittent problems).	Use the customer-reported symptoms and go to Error Symptom-to-FRU Index. Intermittent Problems Undetermined Problems

System Check Procedures

Diskette Drive Check

Do the following to isolate the problem to a controller, driver, cable or diskette. A write-enabled, diagnostic diskette is required.

NOTE: Make sure that the diskette does not have more than one label attached to it. Multiple labels can cause damage to the drive or cause the drive to fail.

Do the following to select the test device.

1. Boot from the diagnostics diskette and start the PQA program.
2. Go to the diagnostic Diskette Drive in the test items.
3. Press F2 in the test items.
4. Follow the instructions in the message window.

If an error occurs with the internal diskette drive, reconnect the diskette connector on the system board.

If the error still remains:

1. Reconnect the diskette drive.
2. Replace the diskette driver cable.
3. Replace the diskette drive.
4. Replace the system board.

CD-ROM Drive Check

Do the following to isolate the problem to a controller, drive, cable, or CD-ROM. Make sure that the CD-ROM does not have any label attached to it. The label can cause damage to the drive or can cause the drive to fail.

Do the following to select the test device:

1. Boot from the diagnostics diskette and start the PQA program.
2. Go to the diagnostic CD-ROM in the test items.
3. Press F2 in the test items.
4. Follow the instructions in the message window.

If an error occurs, reconnect the connector on the System board. If the error still remains:

1. Reconnect the CD-ROM drive.
2. Replace the diskette driver cable.
3. Replace the CD-ROM drive.
4. Replace the system board.

Keyboard or Auxiliary Input Device Check

Remove the external keyboard if the internal keyboard is to be tested.

If the internal keyboard does not work or an unexpected character appears, make sure that the flexible cable extending from the keyboard is correctly seated in the connector on the system board.

If the keyboard cable connection is correct, run the Keyboard Test. See "Running the Diagnostics" for details.

If the tests detect a keyboard problem, do the following one at a time to correct the problem. (Do not replace a non-defective FRU):

1. Reconnect the keyboard cables.
2. Replace the keyboard.
3. Replace the system board.

The following auxiliary input devices are supported by this computer:

- Numeric keypad
- External keyboard

If any of these devices do not work, reconnect the cable connector and repeat the failing operation.

Memory Check

Memory errors might stop system operations, show error messages on the screen, or hang the system.

1. Boot from the diagnostics diskette and start the PQA program (please refer to “Running PQA Diagnostics Program”).
2. Go to the diagnostic memory in the test items.
3. Press F2 in the test items.
4. Follow the instructions in the message window.

NOTE: Make sure that the DIMM is fully installed into the connector. A loose connection can cause an error.

Power System Check

To verify the symptom of the problem, power on the computer using each of the following power sources:

1. Remove the battery pack.
2. Connect the power adapter and check that power is supplied.
3. Disconnect the power adapter and install the charged battery pack; then check that power is supplied by the battery pack.

If you suspect a power problem, see the appropriate power supply check in the following list:

- “Check the Power Adapter”
- “Check the Battery Pack”

Check the Power Adapter

Unplug the power adapter cable from the computer and measure the output voltage at the plug of the power adapter cable. See the following figure

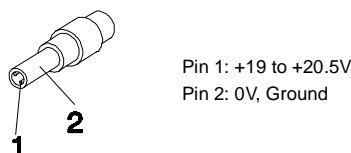

1. If the voltage is not correct, replace the power adapter.
2. If the voltage is within the range, do the following:
 - Replace the System board.
 - If the problem is not corrected, see “Undetermined Problems”.
 - If the voltage is not correct, go to the next step.

NOTE: An audible noise from the power adapter does not always indicate a defect.

3. If the power-on indicator does not light up, check the power cord of the power adapter for correct continuity and installation.
4. If the operational charge does not work, see “Check the Battery Pack”.

Check the Battery Pack

To check the battery pack, do the following:

1. Power off the computer.
2. Remove the battery pack and measure the voltage between battery terminals 1(ground) and 7(+). See the following figure

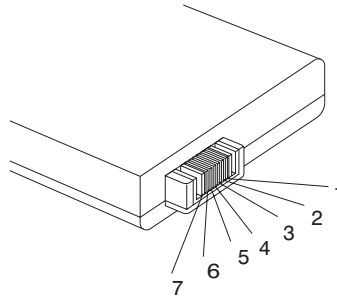

3. If the voltage is still less than 8.0 Vdc after recharging, replace the battery.

To check the battery charge operation, use a discharged battery pack or a battery pack that has less than 50% of the total power remaining when installed in the computer.

If the battery status indicator does not light up, remove the battery pack and let it return to room temperature. Re-install the battery pack.

If the charge indicator still does not light up, replace the battery pack. If the charge indicator still does not light up, replace the system board.

Touchpad Check

If the touchpad doesn't work, do the following actions one at a time to correct the problem. Do not replace a non-defective FRU:

1. Reconnect the touchpad cables.
2. Replace the touchpad cables.
3. Replace the touchpad.
4. Replace the system board.

After you use the touchpad, the pointer drifts on the screen for a short time. This self-acting pointer movement can occur when a slight, steady pressure is applied to the touchpad pointer. This symptom is not a hardware problem. No service actions are necessary if the pointer movement stops in a short period of time.

Index of Error Message

The symptom-to-FRU index lists the symptoms and errors and their possible causes. The most likely cause is listed first.

NOTE: Perform the FRU replacement or actions in the sequence shown in FRU/Action column, if the FRU replacement does not solve the problem, put the original part back in the computer. Do not replace a non-defective FRU.

This index can also help you determine the next possible FRU to be replaced when servicing a computer.

If the symptom is not listed, see “Undetermined Problems” on page 85.

The following lists the error messages that the BIOS displays on the screen and the error symptoms classified by function.

NOTE: Most of the error messages occur during POST. Some of them display information about a hardware device, e.g., the amount of memory installed. Others may indicate a problem with a device, such as the way it has been configured.

NOTE: If the system fails after you make changes in the BIOS Setup Utility menus, reset the computer, enter Setup and install Setup defaults or correct the error

Error Messages List

Error Messages	Action in Sequence
Failure Fixed Disk	Reconnect hard disk drive connector. “Load Default Settings” in BIOS Setup Utility. Hard disk drive System board
Stuck Key	“Keyboard or Auxiliary Input Device Check” .
Keyboard error	“Keyboard or Auxiliary Input Device Check”.
Keyboard Controller Failed	“Keyboard or Auxiliary Input Device Check”.
Keyboard locked - Unlock key switch	Unlock external keyboard.
Monitor type does not match CMOS - Run Setup	Run “Load Default Settings” in BIOS Setup Utility.
Shadow RAM Failed at offset: nnnn	BIOS ROM System board
System RAM Failed at offset: nnnn	DIMM System board
Extended RAM Failed at offset: nnnn	DIMM System board
System battery is dead - Replace and run Setup	Replace RTC battery and Run BIOS Setup Utility to reconfigure system time, then reboot system.
System CMOS checksum bad - Default configuration used	RTC battery Run BIOS Setup Utility to reconfigure system time, then reboot system.
System timer error	RTC battery Run BIOS Setup Utility to reconfigure system time, then reboot system. System board
Real time clock error	RTC battery Run BIOS Setup Utility to reconfigure system time, then reboot system. System board
Previous boot incomplete - Default configuration used	Run “Load Default Settings” in BIOS Setup Utility. RTC battery System board

Error Messages List

Error Messages	Action in Sequence
Memory size found by POST differed from CMOS	Run "Load Default Settings" in BIOS Setup Utility. DIMM System board
Diskette drive A error	Check that the drive is defined with the proper diskette type in BIOS Setup Utility. Diskette Drive Check.
Incorrect Drive A type - run SETUP	Check that the drive is defined with the proper diskette type in BIOS Setup Utility Diskette Drive Check.
System cache error - Cache disabled	System board
CPU ID	System board
DMA Test Failed	DIMM System board
Software NMI Failed	DIMM System board
Fail-Safe Timer NMI Failed	DIMM System board
Device Address Conflict	Run "Load Default Settings" in BIOS Setup Utility. RTC battery System board
Allocation Error for device	Run "Load Default Settings" in BIOS Setup Utility. RTC battery System board
Failing Bits: nnnn	DIMM BIOS ROM System board
Fixed Disk n	None
Invalid System Configuration Data	BIOS ROM System board
I/O device IRQ conflict	Run "Load Default Settings" in BIOS Setup Utility. RTC battery System board
Operating system not found	Enter Setup and see if fixed disk and drive A are properly identified. Diskette drive Hard disk drive System board

No-Beep Symptoms

Symptom / Error	Action in Sequence
No beep, power-on indicator turns off and LCD is blank.	Power source (battery pack and power adapter). Power System Check. Ensure every connector is connected tightly and correctly. Reconnect the DIMM. System board.

No-Beep Symptoms

Symptom / Error	Action in Sequence
No beep, power-on indicator turns on and LCD is blank.	Power source (battery pack and power adapter). Power System Check. Reconnect the LCD connectors Hard disk drive LCD inverter ID LCD cable Inverter LCD System board
No beep, power-on indicator turns on and LCD is blank. But you can see POST on an external CRT.	Reconnect the LCD connectors. LCD inverter ID LCD cable LCD inverter LCD System board
No beep, power-on indicator turns on and a blinking cursor shown on LCD during POST.	Ensure every connector is connected tightly and correctly. System board
No beep during POST but system runs correctly.	Speaker Audio board System board

Index of Symptom-to-FRU Error Message

LCD-Related Symptoms

Symptom / Error	Action in Sequence
LCD backlight doesn't work LCD is too dark LCD brightness cannot be adjusted	Enter BIOS Utility to execute "Load Setup Default Settings", then reboot system. Reconnect the LCD connectors. Keyboard (if contrast and brightness function key doesn't work). LCD inverter ID LCD cable LCD inverter LCD System board
Unreadable LCD screen Missing pixels in characters Abnormal screen Wrong color displayed	Reconnect the LCD connectors. LCD inverter ID LCD cable LCD inverter LCD System board
LCD has extra horizontal or vertical lines displayed.	LCD inverter ID LCD inverter LCD cable LCD System board

Indicator-Related Symptoms

Symptom / Error	Action in Sequence
Indicator incorrectly remains off or on, but system runs correctly.	Reconnect the LED board LED board System board

Power-Related Symptoms

Symptom / Error	Action in Sequence
Power shuts down during operation.	Power source (battery pack and power adapter). Power System Check. Battery pack Power adapter Audio board System board
The system doesn't power-on.	Power source (battery pack and power adapter). Power System Check. Battery pack Power adapter Audio board System board
The system doesn't power-off.	Power source (battery pack and power adapter). Power System Check. Hold and press the power switch for more than 4 seconds. System board

Power-Related Symptoms

Symptom / Error	Action in Sequence
Battery can't be charged	Power System Check Battery pack System board

PCMCIA-Related Symptoms

Symptom / Error	Action in Sequence
System cannot detect the PC Card (PCMCIA)	PCMCIA slot assembly System board
PCMCIA slot pin is damaged.	PCMCIA slot assembly

Memory-Related Symptoms

Symptom / Error	Action in Sequence
Memory count (size) appears different from actual size.	Enter BIOS Setup Utility to execute "Load Default Settings, then reboot system. DIMM System board

Speaker-Related Symptoms

Symptom / Error	Action in Sequence
In DOS or Windows, multimedia programs, no sound comes from the computer.	Press Fn-F8, Speaker ON/OFF control. Audio driver Speaker Audio board System board
Internal speakers make noise or emit no sound.	Press Fn-F8, Speaker ON/OFF control. Speaker Audio board System board

Power Management-Related Symptoms

Symptom / Error	Action in Sequence
The system will not enter hibernation	Keyboard (if control is from the keyboard) Hard disk drive System board Check with Sleep Manager.
The system doesn't enter hibernation mode and four short beeps every minute.	Hibernation Mode Press Fn+F4 and see if the computer enters hibernation mode. Touchpad Keyboard Hard disk connection board Hard disk drive System board
The system doesn't enter standby mode after closing the LCD	Standby Mode LCD cover switch System board
The system doesn't resume from hibernation mode.	Hibernation Mode Hard disk connection board Hard disk drive System board

Power Management-Related Symptoms

Symptom / Error	Action in Sequence
The system doesn't resume from standby mode after opening the LCD.	Standby Mode LCD cover switch System board
Battery fuel gauge in Windows doesn't go higher than 90%.	Remove battery pack and let it cool for 2 hours. Refresh battery (continue to use battery until power off, then charge battery). Battery pack System board
System hangs intermittently.	Set Thermal Sensor Threshold. Reconnect hard disk/CD-ROM drives. Hard disk connection board System board

Peripheral-Related Symptoms

Symptom / Error	Action in Sequence
System configuration does not match the installed devices.	Enter BIOS Setup Utility to execute "Load Default Settings", then reboot system. Reconnect hard disk/CD-ROM/diskette drives.
External display does not work correctly.	Press Fn+F5, LCD/CRT/Both display switching Running PQA Diagnostics Program. System board
USB does not work correctly.	System Diagnostics Diskette System board
Print problems.	Ensure that the "Parallel Port" in the "Onboard Devices Configuration" of BIOS Setup Utility is set to Enabled. Onboard Devices Configuration Run printer self-test. Printer driver Printer cable Printer System Board
Serial or parallel port device problems.	Ensure that the "Serial Port" in the "Onboard Devices Configuration" of BIOS Setup Utility is set to Enabled. Device driver Device cable Device System board

Keyboard/Touchpad-Related Symptoms

Symptom / Error	Action in Sequence
Keyboard (one or more keys) does not work.	Reconnect the keyboard cable. Keyboard System board
Touchpad does not work.	Reconnect touchpad cable. Touchpad board System board

Modem-Related Symptoms

Symptom / Error	Action in Sequence
Internal modem does not work correctly.	System Diagnostics Diskette Modem phone jack Modem board System board

NOTE: If you cannot find a symptom or an error in this list and the problem remains, see “Undetermined Problems” on page 85.

Intermittent Problems

Intermittent system hang problems can be caused by a variety of reasons that have nothing to do with a hardware defect, such as: cosmic radiation, electrostatic discharge, or software errors. FRU replacement should be considered only when a recurring problem exists.

When analyzing an intermittent problem, do the following:

1. Run the advanced diagnostic test for the system board in loop mode at least 10 times.
2. If no error is detected, do not replace any FRU.
3. If any error is detected, replace the FRU. Rerun the test to verify that there are no more errors.

Undetermined Problems

The diagnostic problems does not identify which adapter or device failed, which installed devices are incorrect, whether a short circuit is suspected, or whether the system is inoperative.

Follow these procedures to isolate the failing FRU (do not isolate non-defective FRU).

NOTE: Verify that all attached devices are supported by the computer.

NOTE: Verify that the power supply being used at the time of the failure is operating correctly.

1. Power-off the computer.
2. Visually check them for damage. If any problems are found, replace the FRU.
3. Remove or disconnect all of the following devices:
 - Non-Acer devices
 - Devices attached to the port replicator
 - Printer, mouse, and other external devices
 - Battery pack
 - Hard disk drive
 - DIMM
 - CD-ROM
 - Diskette drive
 - PC Cards
4. Power-on the computer.
5. Determine if the problem has changed.
6. If the problem does not recur, reconnect the removed devices one at a time until you find the failing FRU.
7. If the problem remains, replace the following FRU one at a time. Do not replace a non-defective FRU:
 - System board
 - LCD assembly

Index of PQA Diagnostic Error Code, Message

Error Message	Action in Sequence
Hardware Error	See "System Diagnostic Diskette" on page 40
BIOS Update Program Error	Turn off the power and restart the system.
System Error	Make sure this AFlash BIOS diskette for this model.
Without AC adapter	make sure to connect AC adapter
Battery Low	make sure to install a highly charged battery, and reboot system.

Index of PQA Diagnostic Error Code, Message

Error Code	Message	Action in Sequence
16XXX	Backup battery error	Backup battery
01XXX	CPU or main board error	Reload BIOS default setting. System board
02XXX	Memory error	DIMM System board
03XXX	Keyboard error	Reset Keyboard Keyboard System board
04XXX	Video error	System board
05XXX	Parallel Port error	System board
06XXX	Serial port or main board error	System board
07XXX	Diskette drive error	Diskette drive System board
08XXX	Hard disk error	Reload BIOS default setting Hard disk System board
09XXX	CD-ROM error	Reset CD-ROM cable CD-ROM drive System board
10XXX	Co-processor error	System board
11XXX	Pointing device error	Reset Keyboard Keyboard System board
12XXX	Cache test error	System board

Jumper and Connector Locations

Top View

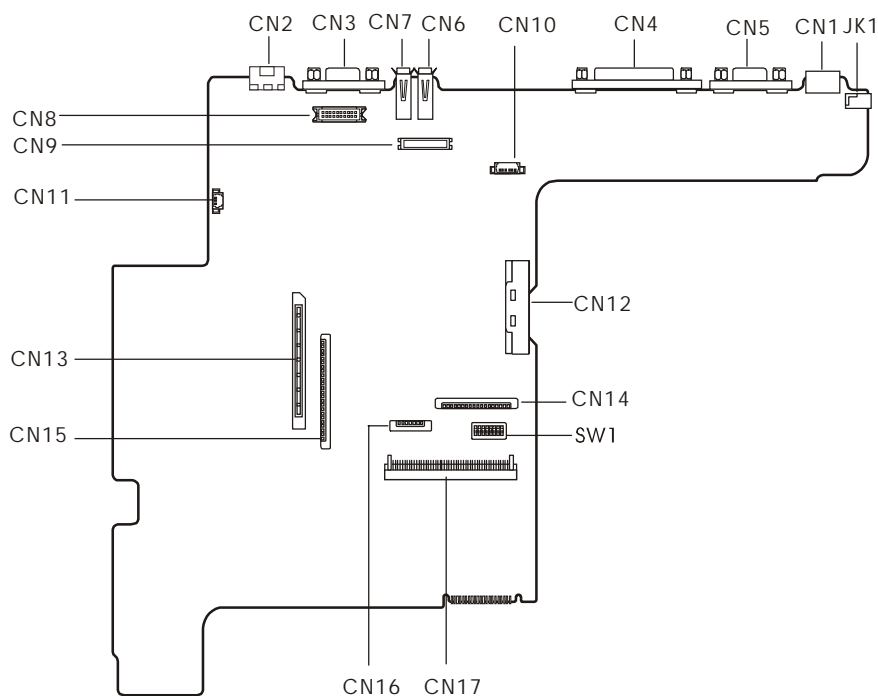

PCB No. 00218

CN1	PS/2 keyboard and Mouse Port	CN11	Fan Connector
CN2	Modem Port	CN12	CD-ROM Connector
CN3	External Display Port	CN13	PCMCIA Socket Connector
CN4	Parallel Port	CN14	Keyboard Cable Connector
CN5	Serial Port	CN15	Diskette Drive Connector
CN6	USB Port 1	CN16	Touch Pad Calbe Connector
CN7	USB Port 2	CN17	Hdd Connector
CN8	LED & Inverter Connector	JK1	DC-in Port
CN9	LCD Connector	SW1	Switch
CN10	Launch Key Connector		

Keyboard Switch Settings

	SW-1	SW-2	SW-3
English	OFF	OFF	OFF
Japanese	ON	OFF	OFF
European	OFF	ON	OFF

SW-4/5

	SW-4	SW-5
Acer	OFF	OFF
Hitachi	ON	OFF
OEM2	OFF	ON
OEM3	ON	ON

SW-6: Check Password

SW-6 = ON, Enable

SW-6 = OFF, Disable

SW-7: Boot Block Boot

SW-7 = OFF, Disable

SW-7 = On, Enable

Bottom View

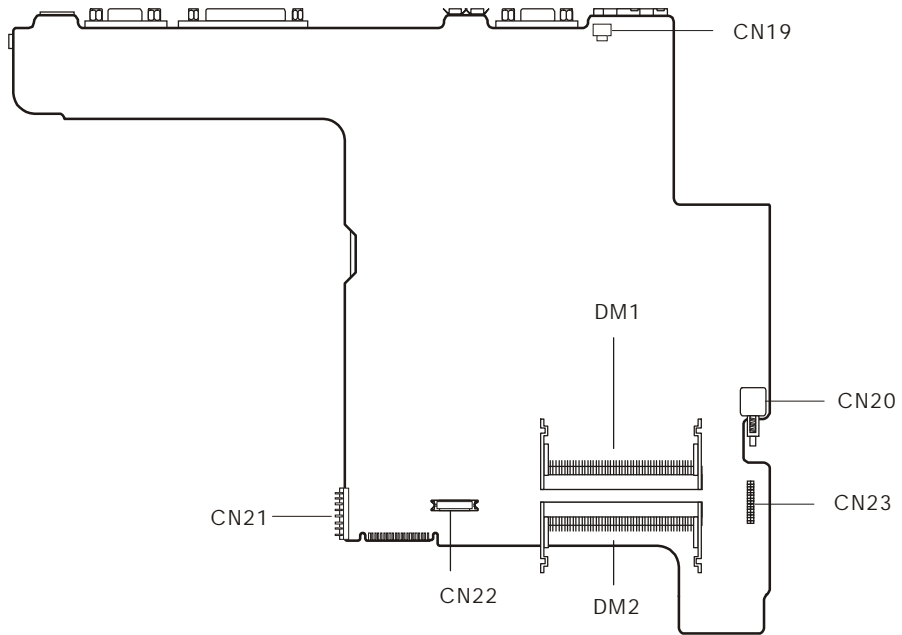





CN19	Modem Card Cable Connector	CN23	Audio Connector
CN20	Power Push Switch	DM1	DIMM 1 Socket(Reverse)
CN21	Battery Connector	DM2	DIMM 2 Socket
CN22	Modem Connector		





FRU (Field Replaceable Unit) List



This chapter gives you the FRU (Field Replaceable Unit) listing in global configurations of TravelMate 210. Refer to this chapter whenever ordering for parts to repair or for RMA (Return Merchandise Authorization).

Please note that WHEN ORDERING FRU PARTS, you should check the most up-to-date information available on your regional web or channel. For whatever reasons a part number change is made, it will not be noted on the printed Service Guide. For ACER AUTHORIZED SERVICE PROVIDERS, your Acer office may have a DIFFERENT part number code from those given in the FRU list of this printed Service Guide. You MUST use the local FRU list provided by your regional Acer office to order FRU parts for repair and service of customer machines.

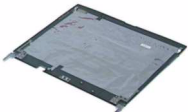





NOTE: To scrap or to return the defective parts, you should follow the local government ordinance or regulations on how to dispose it properly, or follow the rules set by your regional Acer office on how to return it.



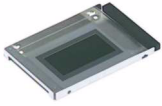

Picture	No.	Partname	Description	Part No.
Memory				
	NS	MEMORY SDIMM 64M WINBOND	SDIMM 64MB W9864CBSA75A V0.175	72.09864.C0E
		MEMORY SDIMM 64M NEC	SODIMM 64MB W17064AHNC8602A	72.17064.G0N
		MEMORY SDIMM 64M PSC	SODIMM 64M P464S3D24U1-11 PC10	72.46424.00N
		MEMORY SDIMM 128M NEC	SODIMM 128MB W17128AHNC8602A	72.17128.D0N
		MEMORY SDIMM 128M WINBOND	SDIMM 128M W9812CBSA-75 V0.175	72.09812.C0E
LCD				
	4	LCD SCREW	CSN SCRW SILICON 050 6*3H 800	47.49A02.001
	7	LCD SCREW	SCREW M2.5*4L NI	86.9A553.4R0
	7	LCD 12.1" SVGA HITACHI/ TX31D35VCICCA	LCD 12.1SVGA HIT/ TX31D35VCICCA	56.0740G.001
	NS	LCD RUBER SCREW	RUBER SCREW DOWM FL2	47.40G02.001
	NS	LCD CABLE	C.A LCD(12.1"HITAH) FALCON2	50.40G07.013
	NS	LED/INVERTER CABLE	C.A LED&INV(12.1"&13.3)FL2	50.40G06.002
	NS	INVERTER	INVERTER T62I172.00 REV.60 FAL	19.21030.C71







Picture	No.	Partname	Description	Part No.
	NS	SPEAKER	SPEAKER13.3& 12.1	60.40G12.013
	NS	LCD BEZEL	LCDBEZEL ASSY(12.1")	60.40G11.006
	NS	LCD PANEL	ASSY LCD PANEL(HIT12.1")F2M	60.40R07.001
	NS	MICROPHONE CABLE	MIC CABLE	50.40G06.011
	NS	LCD SCREW	CSN SCRW SILICON 050 6*	47.49A02.001
	11	LCD SCREW	SCREW M2.5*4L NI	86.9A553.4R0
	NS	AUDIO GASKET	GASKET AUDIO BD 5*5*20	42.00097.181
	3-2	LCD RUBER SCREW	RUBER SCREW DOWM FL2	47.40G02.001
	NS	LCD 13.3" TFT XGA ADT/ L133X2-3B	LCD 13.3"TFT XGA ADT/ L1	56.0741H.041
	NS	LCD SCREW	SCREW WAFER NYLOK NI 2M	86.9A552.3R0
	NS	LCD CABLE	C.A LCD(13.3"ADT)FALCON	50.40G07.032
	NS	GASKET TAPE	GASKET TAPE	34.41J13.001
	NS	LED/INVERTER CABLE	C.A LED&INV(12.1"&13.3)	50.40G06.002
	NS	LCD BRACKET LEFT	LCD BRK - L(ADT13.3")FL2	33.40G08.003
	NS	LCD BRACKET RIGHT	LCD BRK - R(ADT13.3")FL2	33.40G07.003





Picture	No.	Partname	Description	Part No.
	NS	INVERTER	INVERTER T62I172.00 REV	19.21030.C71
	NS	LCD BEZEL	LCD BEZEL ASSY(13.3")	60.40G11.015
	NS	SPEAKER	SPEAKER13.3& 12.1	60.40G12.013
	NS	LCD PANEL	ASSY LCD PANEL(13.3"ADT)F2M	60.40R08.001
	11	LCD SCREW	SCREW M2.5*4L NI	86.9A553.4R0
	NS	LCD SCREW BINDING	SCREW BINDING BL-ZN M2*4L	86.4A322.4R0
	NS	LCD RUBER SCREW	RUBER SCREW DOWN FL2	47.40G02.001
	NS	LCD 14.1"TFT XGA ADT/ L141X1-1	LCD 14.1"TFT XGA ADT/ L141X1-1	56.0741H.031
	NS	SPEAKER LEFT	SPEAKER-L(14.1")FL2.5	60.41H05.002
	NS	SPEAKER RIGHT	SPEAKER-R(14.1")FL2.5	60.41H04.002
	NS	LCD CABLE	C.A LCD(14.1"ADT&UNI)FL2. 5	50.41H01.003
	NS	LED/INVERTER CABLE	CABLE ASSY LED & INV(14.1")FL2	50.41H02.003
	NS	INVERTER	INVERTER T62I172.00 REV.60 FAL	19.21030.C71
	NS	LCD BEZEL	LCD BEZEL ASSY(14.1")	60.41H03.005
	NS	LCD PANEL	ASSY LCD PANEL(ADT14.1")F2M	60.40R09.001
	7	LCD SCREW	SCREW M2.5*4L NI	86.9A553.4R0
	NS	LCD 14.1"XGA UNIPAC/ UB141X01	LCD 14.1"XGA UNIPAC/ UB141X01	56.0741H.011
	10	LCD SCREW BINDING	SCREW BINDING BL-ZN M2*4L	86.4A322.4R0
	3-2	LCD RUBER SCREW	RUBER SCREW DOWM FL2	47.40G02.001
	NS	SPEAKER LEFT	SPEAKER-L(14.1")FL2.5	60.41H05.002
	NS	SPEAKER RIGHT	SPEAKER-R(14.1")FL2.5	60.41H04.002

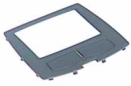





Picture	No.	Partname	Description	Part No.
	NS	LCD CABLE	C.A LCD(14.1"ADT&UNI)FL2. 5	50.41H01.003
	NS	LED/INVERTER CABLE	CABLE ASSY LED & INV(14.1")FL2	50.41H02.003
	NS	INVERTER	INVERTER T621172.00 REV.60 FAL	19.21030.C71
	NS	LCD BEZEL	LCD BEZEL ASSY(14.1")	60.41H03.005
	NS	LCD PANEL	ASSY LCD PANEL(ADT14.1")F2M	60.40R09.001
FDD/Floppy Disk Drive				
	NS	FDD SCREW	SCREW BINDING BL-ZN M2*4L	86.4A322.4R0
	NS	FDD 1.44M MCI/ JU226A252FC	FDD 1.44SLIM MCI/ JU226A252FC(H	56.01041.671
	NS	FDD CABLE	FDD CABLE	50.40G01.002
	NS	FDD BRACKET	FDD BRACKET	33.40G04.002
	NS	FDD BEZEL	FDD BEZEL	60.40G15.012

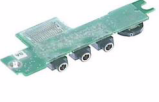

Picture	No.	Partname	Description	Part No.
HDD/ Hard Disk Drive				
	NS	HDD CONECTOR	CONN CTR ML 22P HH98227-A2(HDD	20.80056.022
	NS	HDD SCREW	SCREW M3*4L W/F NI	86.5A524.4R0
	NS	HDD 5G IBM/DJSA-205	HDD 5G IBM/DJSA-205 H31831	56.02017.022
	NS	HDD BRACKET	HDD ASSY(9.5MM)BRACKET FALCON2	60.40G09.003
CD-ROM Drive				
	NS	CD-ROM/DVD-ROM SCREW	SCREW WAFER NYLOK NI 2ML3	86.9A552.3R0
	NS	CD-ROM 24X TEAC/ CD224EB26	CD ROM 24XSL A03 TEA/CD224EB26	56.10061.212
	NS	CD-ROM/DVD-ROM BOARD	FALCON-2 CD-ROMBD	55.40G04.011
	NS	CD-ROM/DVD-ROM SCREW	CD-ROM SPECIAL SCREW	86.00A19.120
	NS	ASSEMBLY CD-ROM PLATE	CD/DVD-ROM ASSY	60.40G13.003
	NS	CD-ROM/DVD-ROM SCREW	SCREW WAFER NYLOK NI 2ML3	86.9A552.3R0

Picture	No.	Partname	Description	Part No.
	NS	CD-ROM/DVD-ROM BOARD	FALCON-2 CD-ROM BD	55.40G04.011
	NS	CD-ROM/DVD-ROM SCREW	CD-ROM SPECIAL SCREW	86.00A19.120
	NS	ASSEMBLY CD-ROM PLATE	CD/DVD-ROM ASSY	60.40G13.003
	NS	CD-ROM 24X MKE/CR-177-BAA	CD ROM 24X MKE/CR-177-BAA 730	56.10289.001
DVD-ROM Drive				
	NS	CD-ROM/DVD-ROM SCREW	SCREW WAFER NYLOK NI 2ML3	86.9A552.3R0
	NS	CD-ROM/DVD-ROM BOARD	FALCON-2 CD-ROM BD	55.40G04.011
	NS	CD-ROM/DVD-ROM SCREW	CD-ROM SPECIAL SCREW	86.00A19.120
	NS	ASSEMBLY CD-ROM PLATE	CD/DVD-ROM ASSY	60.40G13.003
	NS		DVD 8X MKE/SR-8175-BAA2	56.2241H.001
	NS	CD-ROM/DVD-ROM SCREW	SCREW WAFER NYLOK NI 2ML3	86.9A552.3R0
	NS	CD-ROM/DVD-ROM BOARD	FALCON-2 CD-ROM BD	55.40G04.011
	NS	CD-ROM/DVD-ROM SCREW	CD-ROM SPECIAL SCREW	86.00A19.12
	NS	DVD-ROM 8X PIONEER/DVD-K11	DVD 8X PIONEER/DVD-K11	56.2237H.001
	NS	ASSEMBLY CD-ROM PLATE	CD/DVD-ROM ASSY	60.40G13.003

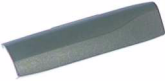
Picture	No.	Partname	Description	Part No.
Heatsink				
	2	HEATSINK	370 CPU HEATSINK FALCON2	34.40G01.001
Fan				
	NS	FAN 5V	FAN 5V 45*45*10 AB4505MB-GD3(B)	23.10041.011
Keyboard				
	NS	KEYBOARD US	KB US NSK-84X21	91.63X07.041
		KEYBOARD US	NKS-84X01 US	91.63X07.001
Pointing Device				
	NS	TOUCHPAD MULTI-SWITCH SYNAPTIC	TOUCHPAD MULTI- SWITCH SYNAPTIC	56.1740C.001
	NS	TOUCH PAD FRAME	TOUCH PAD FRAME FALCON2	41.40G01.001
	NS	TOUCH PAD BUTTON	TOUCH PAD BUTTON FALCON2	42.40G09.001
	NS	TOUCH PAD SCROLL BUTTON	TOUCH PAD SCROLL BUTTON FLCON2	42.40G10.003

Picture	No.	Partname	Description	Part No.
	NS	TOUCH PAD FPC CABLE	CABLE ASSY TOUCHPAD FPC FALCON	50.40G02.004
Cables				
	NS	LAUNCH CABLE	C.ALAUNCHFALCON2	50.40G05.001
Main board				
	NS	MAINBOARD/TM210	TM210T CEL-650 MB	55.40R01.001
Boards				
	NS	LAUNCH BOARD	FALCON2 LAUNCH BOARD	55.40G03.001
	NS	MODEM BOARD	MODEM MDC AMBIT/ U98M005.01	54.09011.301
	NS	AUDIO BOARD	TM210 AUDIO BD (F2M)	55.40R02.001

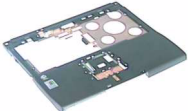
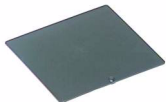
Picture	No.	Partname	Description	Part No.
Adapter				
	NS	ADAPTER 60W 90-264V 3P	ADT 60W 90-264V ADP-60DB BB 3P	25.10064.111
		ADAPTER 3P	ADT 3P PA-1600-02AE W/ACER LOG	25.10068.091
Battery				
	NS	BATTERY PACK BTP-33A1	ASSY BTY PACK BTP-33A1 FAL2	60.40G01.001
Case/Cover/Bracket Assembly				
	NS	I/O BRACKET	ASSY IO BRACKET FALCON 2	60.40G14.001
	14	MODEM COVER	MODEM COVER ASSY	60.40G06.001
	NS	ASSEMBLY HINGE CAP	ASSY HINGE CAP FALCON 2M	6K.40RXX.XXX
	NS	BATTERY DOOR	BATTERY DOOR FALCON2	42.40G01.002
	NS	HINGE CABLE COVER	CABLE COVER (HIGHER) FALCON2	42.40G32.002
	NS	HDD COVER	ASSY HDD COVER FALCON2.5	60.41H14.003
	NS	MIDDLE COVER	MIDDLE COVER ASSY	60.40G07.004

Picture	No.	Partname	Description	Part No.
	NS	UPPER CASE	UPPER CASE ASSEMBLY	60.40G03.008
	NS	DIMM COVER	DIMM COVER ASSY	60.40G05.002
	NS	LOWER CASE	L-CASE ASSY FALCON2	60.40G04.001
Miscellaneous				
	NS	NAME PLATE TM210	PLATE NAME TM210(FOR 210T)	40.40R02.001
Screws				
	22	SCREW M2.5X6	SCREW M2.5X6	86.9A353.6R0
	20	SCREW M2.0*12	SCREW M2.0*12 STEEL B	86.1A322.120
	NS	SCREW BINDING BL-ZN M2*4L	SCREW BINDING BL-ZN M2*4L	86.4A322.4R0

Model Definition and Configuration

Model Number Definitions

Model Number	LCD	CPU	Memory	HDD	CD/DVD	Battery
210T	12.1" TFT	Celeron-700	64MB	10GB	24x CD-ROM	NiMH
210TE	13.3" TFT	Celeron-700	64/128MB	10GB	24x CD-ROM	NiMH
210TEV	13.3" TFT	Celeron-700	64/128MB	10GB	8x DVD	NiMH
210TER(Rev.)	13.3" TFT	Celeron-700	64/128MB	10GB	4/4/20x CD-RW	NiMH
210TXR(Rev.)	14.1" TFT	Celeron-700	64/128MB	10GB	4/4/20x CD-RW	NiMH
211T	12.1" TFT	Celeron-750	64MB	10GB	24x CD-ROM	NiMH
211TE	13.3" TFT	Celeron-750	64/128MB	10GB	24x CD-ROM	NiMH
211TEV	13.3" TFT	Celeron-750	64/128MB	10GB	8x DVD	NiMH
211TX	14.1" TFT	Celeron-750	64/128MB	10GB	24x CD-ROM	NiMH
211TXR	14.1" TFT	Celeron-750	64/128MB	10GB	4/4/20x CD-RW	NiMH
212TXV	14.1" TFT	Celeron-800	64/128MB	10GB	8x DVD-ROM	NiMH

Test Compatible Components

This computer's compatibility is tested and verified by Acer's internal testing department. All of its system functions are tested under Windows Me US ACPI and Windows Me JP ACPI environment.

Refer to the following lists for components, adapter cards, and peripherals which have passed these tests. Regarding configuration, combination and test procedures, please refer to the TravelMate 210 Compatibility Test Report released by the Acer Mobile System Testing Department.

Microsoft Windows ME US/JP ACPI Environment Test

Item	Specifications
Processor	Celeron 650MHz, 128k Celeron 700MHz, 128k
Memory	NEC 64MB Winbond 64MB NEC 128MB Winbond 128MB
LCD	12.1" SVGA TFT (Hitachi) 13.3" XGA TFT (ADT) 14.1" XGA TFT (ADT) 14.1" XGA TFT (Unipac)
Floppy Disk Drive	MCI
Hard Disk Drive	IBM 5GB IBM 10GB
CD-ROM	MKE 24X TEAC 24X
DVD-ROM	MKE 8X Pioneer 8X
Battery	Sanyo NiMH
AC Adapter	Delta / ADP-60DB (3pin) Lite-on / Pa-1600-2 (3pin)
SW Modem	Ambit 56K modem
Keyboard	API
Power cord	3pin US 2pin
VGA Chip	Trident CyberBlade ALi integrated in ALi M1632
Audio	AC-Link Controller Audio built-in the ALi M1535
Touch Pad	Synaptics
Inverter	AMBIT

Online Support Information

This section describes online technical support services available to help you repair your Acer Systems.

If you are a distributor, dealer, ASP or TPM, please refer your technical queries to your local Acer branch office. Acer Branch Offices and Regional Business Units may access our website. However some information sources will require a user i.d. and password. These can be obtained directly from Acer CSD Taiwan.

Acer's Website offers you convenient and valuable support resources whenever you need them.

In the Technical Information section you can download information on all of Acer's Notebook, Desktop and Server models including:

- Service guides for all models
- User's manuals
- Training materials
- Main manuals
- Bios updates
- Software utilities
- Schematics
- Spare parts lists
- Chips
- TABs (Technical Announcement Bulletin)

The service repair section provides you with downloadable information on:

- Troubleshooting guides
- Tooling box information
- Repair instructions for specific models
- Basic repair guidelines
- Debug cards for Acer's latest models

For these purposes, we have included an Acrobat File to facilitate the problem-free downloading of our technical material.

Also contained on this website are:

- Detailed information on Acer's International Traveller's Warranty (ITW)
- Returned material authorization procedures
- An overview of all the support services we offer, accompanied by a list of telephone, fax and email contacts for all your technical queries.

We are always looking for ways to optimize and improve our services, so if you have any suggestions or comments, please do not hesitate to communicate these to us.

A

- AC Adapter 25
- AFLASH Utility 37
- Audio 17, 21

B

- Battery 23
 - battery pack
 - charging indicator 10
- BIOS 17
 - package 17
 - ROM size 17
 - ROM type 17
 - vendor 17
 - Version 17
- BIOS Setup Utility 29
- BIOS Supports protocol 17
- BIOS Utility 29–36
 - Basic System Settings 31
 - Load Default Settings 36
 - Navigating 29
 - Onboard Device Configuration 33
 - Startup Configuration 32
 - System Information 30
 - System Security 34
- Board Layout 4
 - Bottom View 5
 - Top View 4
- brightness
 - hotkeys 13

C

- Cache
 - controller 17
 - size 17
- caps lock
 - on indicator 10
- CardBus 23
- CD-ROM Interface 20
- Chipsets 17
- computer
 - on indicator 10
- contrast
 - hotkeys 13

- Controllers 17
- Core logic 17
- CPU
 - core voltage 17
 - I/O voltage 17
 - package 17
 - type 17

D

- DC-AC LCD Inverter 24
- DC-DC/Charger 23
- Design 2
- DIMM 17
 - Combinations 18
 - package 18
 - Speed 18
 - voltage 18
- Disassembly Flowchart 45
- Display 2
 - display
 - hotkeys 13
 - Display Standby Mode 26
- DMA Channel Assignment 28
- DVD-ROM Interface 20

E

- Environmental Requirements 26
- External CD-ROM Drive Check 74

F

- Features 1
- Flash Utility 37
- Floppy Disk Drive Interface 19
- FRU (Field Replaceable Unit) List 93

H

- Hard disk 17, 19
- Hard Disk Drive Module
 - Disassembly 51
- Hard Disk Standby Mode 26
- Hardware Specifications and Configurations 15
- HDD 17, 19
- Hibernation Mode 26
- Hibernation mode

hotkey 13
Hot Keys 13

I

I/O Address Map 27
Index of Error Message 77
 No-Beep Symptoms 78
Index of Symptom-to-FRU Error Message 80
 Indicator 80
 Keyboard 82
 LCD 80
 Memory 81
 Modem 83
 PCMCIA 81
 Peripheral 82
 Power 80
 Power Management 81
 Speaker 81
 Touchpad 82
Indicators 10
Intermittent Problems 84
IRQ Assignment Map 28

J

Jumper and Connector Locations
 Bottom View 91
 SW2 Settings 89
 Top View 89, 91

K

Keyboard 17, 23
Keyboard or Auxiliary Input Device Check 74

L

L2 cache 17
LCD 24

M

Machine Disassembly and Replacement 43
Mechanical Specification 27
media access
 on indicator 10
Memory
 Address Map 27
Memory Address Map 27
Memory Check 75
Model Number Definitions 105
Modem 18

N

Notebook Manager
 hotkey 13
num lock
 on indicator 10

O

Online Support Information 109

P

Panel 5
 Bottom 9
 Rear 8
 right 8
Parallel Port 22
parallel port
 setting in BIOS Utility 33
Password Setting
 Hard Disk Password 35
 Power-On Password 35
 Setup Password 35
PC Card 10, 23
PCMCIA 23
Power Management 26
Power management 2
Power System Check 75
 Battery Pack 76
 Power Adapter 75
PQA 40
Processor 17

R

Removing the Battery Pack 48
RMA 93
RTC 17

S

Second Level Cache 17
Serial Port 22
speakers
 hotkey 13
Standby Mode 26
Super I/O 17
System
 Block Diagram 3
 Layout 4
System Check Procedures 74
System Diagnostic Diskette 40
System Memory 17
System Utilities 29

System Utility Diskette 38

T

Temperature 26

Test Compatible Components 107

Touchpad 15

touchpad

hotkey 13

Touchpad Check 76

Troubleshooting 73

U

Undetermined Problems 85

USB 23

utility

BIOS 29–36

V

Video 21, 22

Resolutions 22

Video controller 17

W

Windows 98 SE/98 JP SE ACPI Environment Test
108

